

K RAIN® PRODUCT GUIDE

Authorized Partner



NATURALIST d.o.o. • Petra Konjovića 12-ž, 11090 Beograd, Srbija
Tel: +381 11 7514898 • Fax: +381 11 7514899
e-mail: naturalist.office@gmail.com • e-mail: office@naturalist.rs
www.naturalist.rs

CONTENTS

ROTORS

02 - 03 MINIPRO

04 - 05 RPS50

06 - 07 RPS75

08 - 11 PROPLUS

12 - 15 SUPERPRO

16 - 19 PROCOM

20 - 23 PROSPORT

23 - 25 SPRAYS

26 - 27 ADJUSTABLE ROTARY NOZZLES

28 - 31 SPRAY NOZZLES AND BUBBLERS

32 - 38 ELECTRIC VALVES

40 - 43 CONTROLLERS

SPECIALTY PRODUCTS

44 SINGLE STATION CONTROLLER

45 PUMP START RELAYS

46 - 47 INDEXING VALVES

48 - 49 RECLAIMED WATER PRODUCTS

50 - 60 CHARTS

61 WARRANTY



PROFESSIONALS RELY ON K-RAIN IN OVER 63 COUNTRIES.

Shouldn't you?

K-Rain® is one of the world's foremost manufacturers of gear-driven rotors, sprinklers, sprays, controllers and valves for the commercial and residential irrigation markets. With more than 90 patents and over 30 years of industry experience, our advanced design and engineering have made K-Rain products the easiest to install, set and use.

K-Rain has been exceeding expectations in the harshest proving ground, the field, for over 30 years. The natural setting of the real world is the perfect testing facility for our industry leading irrigation products. We didn't read the book on turf irrigation, we wrote it.

K-Rain began with a vision. Beginning with design of an automatic irrigation control system for his home, K-Rain founder Carl Kah currently holds over 90 patents specific to the industry. This was the foundation of K-Rain – our history. Today over 300 men and woman make up the K-Rain team, serving customers in the United States and across the globe.

Beyond any technical advancement, these people are at the heart of all we do. We are proud to say *"We love what we do. Everyday we go to work with one thought: Make it better."*

– Carl Kah, Founder



MODELS

13003	MiniPro - 4"
13006	MiniPro - 6"
13012	MiniPro - 12"

OTHER OPTIONS: ADD TO PART NUMBER

-CV	Check Valve
-NN	No Nozzle
-RCW	Reclaimed Water Use

MINIPRO™ 13003

Perfect for small lawn and landscape areas and for replacing fixed sprays.

When considering the industry leading MINIPRO™ gear driven rotor, think water efficiency. Now available in three popular heights and compatible with a wide selection of nozzles, the MINIPRO™ brings flexibility to system design.



FEATURES/BENEFITS

- Revolutionary Patented Easy Arc Set—Simplified arc set allows for wet or dry adjustment in seconds.
- 1/2" Inlet—Replaces all standard mini rotors and pop-up sprays.
- Adjustable to 360°—Provides a full range of adjustment from 40° to 360°
- Patented Arc Set Degree Markings—Clearly indicates the current watering pattern and simplifies arc set adjustment.
- Time Proven Patented Reversing Mechanism—Assures continuous reverse and return...over a 20 year history.
- Ratcheting Riser—Allows for easy adjustment of your left starting position with a simple turn of the riser.
- Rubber Cover—Seals out dirt and increases product durability.
- Wide Selection of Nozzles—Provides flexibility in system design.
- Optional Check Valve—Prevents low head drainage.
- Five Year Limited Warranty.



HOW TO SPECIFY

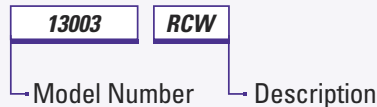

EASY ARC SETTING



- Arc Selection 40° to 360°
Adjust From Left Start

MINIPRO ■ PERFORMANCE DATA

PERFORMANCE			
NOZZLE	PRESSURE PSI	RADIUS FT.	FLOW GPM
#0.75	30	17'	.75
	40	17'	.8
	50	18'	.9
#1	30	20'	.9
	40	21'	1.2
	50	21'	1.3
#1.5 PRE-INSTALLED	30	23'	1.4
	40	24'	1.7
	50	24'	1.9
#2	30	25'	1.8
	40	27'	2.1
	50	27'	2.4
#3	30	28'	2.7
	40	30'	3.0
	50	30'	3.3

METRIC					
NOZZLE	PRESSURE		RADIUS METERS	FLOW RATE	
	kPa	BARS		L/M	M ³ /H
#0.75	207	2.1	5.1	2.84	.2
	276	2.8	5.1	3.03	.2
	345	3.4	5.4	3.41	.2
#1	207	2.1	6.0	3.41	.2
	276	2.8	6.3	4.54	.3
	345	3.4	6.3	4.92	.3
#1.5 PRE-INSTALLED	207	2.1	6.9	5.30	.4
	276	2.8	7.2	6.44	.4
	345	3.4	7.2	7.20	.5
#2	207	2.1	7.5	6.82	.5
	276	2.8	8.1	7.95	.5
	345	3.4	8.1	9.09	.6
#3	207	2.1	8.4	10.2	.7
	276	2.8	9.0	11.4	.8
	344	3.4	9.0	12.5	.8

Data represents test results in zero wind. Adjust for local conditions. Radius may be reduced with nozzle retention screw.

SPECIFICATIONS

- Inlet: 1/2" Threaded NPT
- Arc Adjustment Range: 40° to 360°
- Flow Range: .75-3.3 GPM
- Pressure Rating: 20-70 PSI
- Precipitation Rate: .22 to .41 Inches Per Hour (Depending on Spacing and Nozzle Used)
- Overall Height (Popped Down): 6"
- Recommended Spacing: 17' to 28'
- Radius: 17' to 30'
- Nozzle Trajectory: 26°
- Riser Height: 4", 6" or 12"

FACT

K-RAIN pioneered the flat blade screw driver method of rotor adjustment in 1989.

K-RAIN MINIPRO™ MODEL 13003



The MiniPro is a gear-driven, rotary type sprinkler, capable of covering an area of 17' to 30' (5.2 to 9.1 M) radius at nozzle pressure of 30 to 50 PSI (2.1 to 3.4 bar) with a discharge rate of .75 to 3.3 GPM (2.84 to 12.5 LPM). The MiniPro is supplied with five (5) numerically coded interchangeable nozzles. Sprinkler nozzle trajectory is 26°. The sprinkler has a stainless steel radius adjustment screw.

The MiniPro provides arc adjustment from 40° to 360°. Sprinkler arc setting adjustment is carried out by rotation of a flat blade screwdriver within top cover adjustment slot. Sprinkler coverage pattern is indicated by degree graduations and an arrow located on top of the sprinkler. The MiniPro is adjustable in all phases of installation (i.e., before installation, after installation while static, and after installation while in operation).

MODELS

RPS50	RPS 50 Rotor
--------------	--------------

OTHER OPTIONS: ADD TO PART NUMBER

-CV	Check Valve
-NN	No Nozzle
-RCW	Reclaimed Water Use

RPS50™

The RPS 50 gear drive is designed for smaller areas and is available with a wide selection of nozzles that bring flexibility to system design.



FEATURES/BENEFITS

- Right position start – rotor rotates counterclockwise from fixed right start position.
- Time proven patented reversing mechanism – Assures continuous reverse and return...over a 20 year history.
- Ratcheting riser – allows for easy adjustment of your right starting position with a simple turn of the riser.
- Rubber cover – seals out dirt and increases product durability.
- Wide selection of nozzles – provides flexibility in system design.
- Optional check valve – prevents low head drainage.
- Five year limited warranty



HOW TO SPECIFY

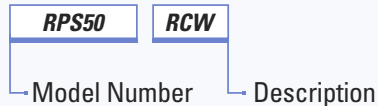

EASY ARC SETTING



- Arc Selection 40° to 360°
Adjust From Right Start

RPS50 ■ PERFORMANCE DATA

PERFORMANCE			
NOZZLE	PRESSURE PSI	RADIUS FT.	FLOW GPM
#0.75	30	17'	.75
	40	17'	.8
	50	18'	.9
#1	30	20'	.9
	40	21'	1.2
	50	21'	1.3
#1.5 PRE-INSTALLED	30	23'	1.4
	40	24'	1.7
	50	24'	1.9
#2	30	25'	1.8
	40	27'	2.1
	50	27'	2.4
#3	30	28'	2.7
	40	30'	3.0
	50	30'	3.3

METRIC					
NOZZLE	PRESSURE		RADIUS METERS	FLOW RATE	
	kPa	BARS		L/M	M ³ /H
#0.75	207	2.1	5.1	2.84	.2
	276	2.8	5.1	3.03	.2
	345	3.4	5.4	3.41	.2
#1	207	2.1	6.0	3.41	.2
	276	2.8	6.3	4.54	.3
	345	3.4	6.3	4.92	.3
#1.5 PRE-INSTALLED	207	2.1	6.9	5.30	.4
	276	2.8	7.2	6.44	.4
	345	3.4	7.2	7.20	.5
#2	207	2.1	7.5	6.82	.5
	276	2.8	8.1	7.95	.5
	345	3.4	8.1	9.09	.6
#3	207	2.1	8.4	10.2	.7
	276	2.8	9.0	11.4	.8
	344	3.4	9.0	12.5	.8

Data represents test results in zero wind. Adjust for local conditions. Radius may be reduced with nozzle retention screw.

SPECIFICATIONS

- Inlet: 1/2 " Threaded NPT
- Arc adjustment range: 40 to 360
- Flow range: .75 – 3.3 GPM
- Pressure Rating: 20-70 psi
- Precipitation Rate: .22 to .41 inches per hour (depending on space and nozzle used)
- Overall height (popped down): 6"
- Recommended spacing: 17' to 28'
- Radius: 17' to 30'
- Nozzle trajectory: 26°
- Riser height: 4"

K-RAIN RPS50™



The RPS50 is a gear-driven, rotary type sprinkler, capable of covering an area of 17' to 30' (5.2 to 9.1 M) radius at nozzle pressure of 30 to 50 PSI (2.1 to 3.4 bar) with a discharge rate of .75 to 3.3 GPM (2.84 to 12.5 LPM). The RPS50 is supplied with five (5) numerically coded interchangeable nozzles. Sprinkler nozzle trajectory is 26°. The sprinkler has a stainless steel radius adjustment screw and has arc adjustment from 40° to 360°.

MODELS

RPS75 RPS 75 Rotor

OTHER OPTIONS: ADD TO PART NUMBER

-CV Check Valve
-NN No Nozzle
-RCW Reclaimed Water Use



RPS75™

The RPS75™ gear drive is designed for basic residential and light commercial applications and is a direct replacement for Hunter® PGP® rotors. The reversing mechanism, a K-Rain patented feature, is the same mechanism used in the Hunter® PGP® (K-Rain currently licenses this patent to Hunter®). With K-Rain's wide selection of standard and low angle nozzles, the RPS75 provides even water distribution.

FEATURES/BENEFITS

- Direct replacement for Hunter® PGP®.
- Right Position Start–Rotor rotates counterclockwise from fixed right start position.
- Riser fits in existing Hunter® PGP® cans–simply unscrew the existing riser from the PGP® can and replace with the RPS75 riser.
- Top adjustment–no training necessary, the RPS75 has the same adjustment procedure as the Hunter® PGP®.
- Full and Part circle rotation–provides a full range of adjustment from 40° to 360°.
- Non-flushing wiper seal–reduces leaks caused by debris trapped under seal.
- 3/4" Inlet–Replaces all standard rotors.
- Ideal for low flow applications.
- Universal adjustment tool–compatible with existing Hunter® products.
- Rubber Cover–Seals out dirt and increases product durability.
- Wide Selection of Nozzles–Including standard and low angle, provides flexibility in system design.
- Five Year Limited Warranty.

SPECIFICATIONS

- Inlet: 3/4" Threaded NPT
- Arc Adjustment Range: 40° to 360°
- Flow Range: .75 – 8.2 GPM
- Pressure Rating: 30 – 70 PSI
- Precipitation Rate: .12 to 1.16 Inches Per Hour
- Overall Height (Popped Down): 7 3/8"
- Recommended Spacing: 25' to 45'
- Radius: 22' to 51'
- Nozzle Trajectory: 25°
- Low Angle Nozzle Trajectory: 11°
- 8 Standard and 4 Low Angle Nozzles Included
- Riser Height: 4"

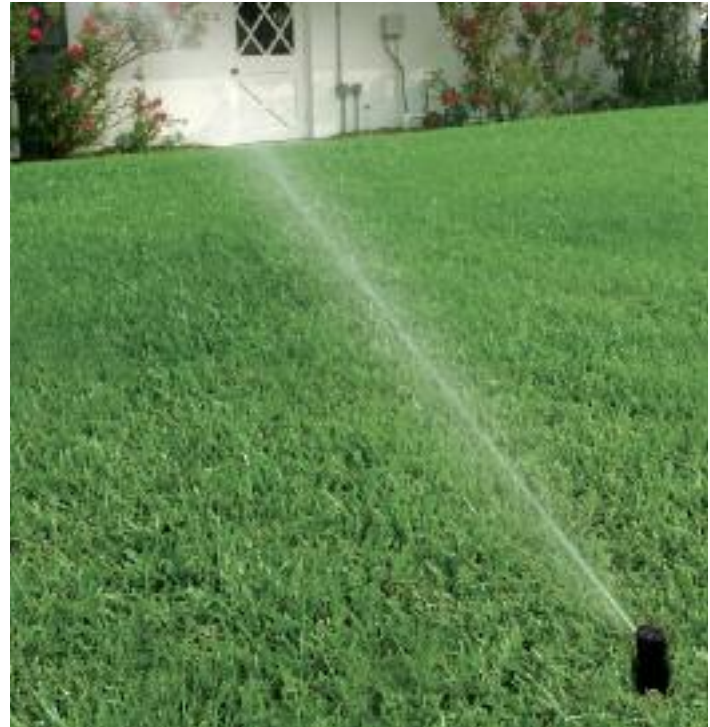

HOW TO SPECIFY

RPS75 **-RCW**
Model Number Description

EASY ARC SETTING

 Arc Selection 40° to 360°
Adjust From Right Start

RPS75 ■ PERFORMANCE DATA

PERFORMANCE				METRIC					
NOZZLE	PRESSURE PSI	RADIUS FT.	FLOW GPM	NOZZLE	PRESSURE		RADIUS METERS	FLOW RATE	
					kPa	BARS		L/M	M ³ /H
#0.75	30	29'	.7	#0.75	206	2.1	8.8	2.6	.16
	40	30'	.8		275	2.8		3.0	.18
	50	30'	.9		344	3.4		3.4	.20
	60	31'	1.0		413	4.1		3.8	.23
#1	30	30'	0.9	#1	206	2.1	9.1	3.4	.20
	40	31'	1.0		275	2.8		3.8	.23
	50	31'	1.2		344	3.4		4.5	.27
	60	32'	1.3		413	4.1		4.9	.30
#1.5	30	32'	1.2	#1.5	206	2.1	9.8	4.5	.27
	40	33'	1.4		275	2.8		5.3	.32
	50	34'	1.6		344	3.4		6.1	.36
	60	34'	1.8		413	4.1		6.8	.41
#2	30	34'	1.6	#2	206	2.1	10.4	6.1	.36
	40	36'	1.8		275	2.8		6.8	.41
	50	38'	2.0		344	3.4		7.6	.45
	60	38'	2.2		413	4.1		8.3	.50
#3 PRE-INSTALLED	30	36'	2.0	#3 PRE-INSTALLED	206	2.1	11.0	7.6	.45
	40	38'	2.4		275	2.8		9.1	.55
	50	40'	2.7		344	3.4		10.2	.61
	60	40'	2.9		413	4.1		11.0	.66
#4	30	36'	2.6	#4	206	2.1	11.0	9.8	.59
	40	40'	3.0		275	2.8		11.4	.68
	50	42'	3.4		344	3.4		12.9	.77
	60	42'	3.7		413	4.1		14.0	.84
#6	40	38'	4.2	#6	206	2.1	11.6	15.9	.91
	50	43'	4.9		275	2.8		18.5	1.11
	60	46'	5.5		344	3.4		20.8	1.25
	70	47'	6.0		413	4.1		22.7	1.36
#8	40	45'	6.0	#8	275	2.8	13.7	22.7	1.36
	50	48'	6.8		344	3.4		25.7	1.54
	60	49'	7.6		413	4.1		28.8	1.73
	70	51'	8.2		482	4.8		31.0	1.86

LOW ANGLE DATA				METRIC					
NOZZLE	PRESSURE PSI	RADIUS FT.	FLOW GPM	NOZZLE	PRESSURE		RADIUS METERS	FLOW RATE	
					kPa	BARS		L/M	M ³ /H
#1	30	22'	1.2	#1	207	2.0	6.7	4.5	.34
	40	24'	1.7		275	3.0		6.4	.39
	50	26'	1.8		344	3.5		6.8	.41
	60	28'	2.0		413	4.0		7.6	.46
#3	30	29'	3.0	#3	207	2.0	8.8	11.4	.68
	40	32'	3.1		275	3.0		11.7	.71
	50	35'	3.5		344	3.5		13.2	.80
	60	37'	3.8		413	4.0		14.4	.87
#4	30	31'	3.4	#4	207	2.0	9.4	12.9	.78
	40	34'	3.9		275	3.0		14.8	.89
	50	37'	4.4		344	3.5		16.7	1.00
	60	38'	4.7		413	4.0		17.8	1.07
#6	40	38'	6.5	#6	275	3.0	11.6	24.6	1.68
	50	40'	7.3		344	3.5		27.6	1.66
	60	42'	8.0		413	4.0		30.3	1.82
	70	44'	8.6		482	5.0		32.6	1.96

Data represents test results in zero wind. Adjust for local conditions. Radius may be reduced with nozzle retention screw.

MODELS

11003	ProPlus
11003-HP	ProPlus 12" High Pop
11003-SH	ProPlus Shrub Head

OTHER OPTIONS: ADD TO PART NUMBER

-CV	Check Valve
-LA	Low Angle Nozzle
-NN	No Nozzle
-RCW	ProPlus for Reclaimed Water w/Low Angle Nozzle

PROPLUS™ 11003

The PROPLUS™ adjustable arc and full-circle gear driven rotor comes standard with nine numerically coded interchangeable nozzles. The flagship model in the PROPLUS™ line, it's packed with features that ensure reliability, saving the installer time, money and needless frustration. Excellent nozzle performance delivers an exceptional fall out pattern. In independent testing by C.I.T., the PROPLUS™ delivered up to 90% uniform coverage.

Tough, proven and advanced, the PROPLUS™ is the leader in it's class. *Set it and forget it.* Arc Memory Clutch returns the rotor to its preset position. Technology works for you.



FEATURES/BENEFITS

- Revolutionary Patented Easy Arc Set—Simplified arc set allows for wet or dry adjustment in seconds.
- 5" Riser—Perfect for grasses with thick thatch.
- 3/4" Inlet—Replaces all standard rotors.
- 2N1 Adjustable or Continuous Rotation—Provides a full range of adjustment from 40° to a continuous full circle.
- Patented Arc Set Degree Markings—Clearly indicates the current watering pattern and simplifies arc set adjustment.
- Arc Memory Clutch—Prevents internal gear damage and returns rotor to its prior setting automatically if nozzle turret is forced past its stop.
- Time Proven Patented Reversing Mechanism—Assures continuous reverse and return...over a 20 year history.
- Ratcheting Riser—Allows for easy adjustment of your left starting position with a simple turn of the riser.
- Rubber Cover—Seals out dirt and increases product durability.
- Wide Selection of Nozzles—Including standard and low angle, provides flexibility in system design.
- Optional Check Valve—Prevents low head drainage.
- Five Year Limited Warranty.



HOW TO SPECIFY

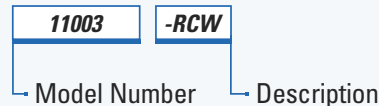

EASY ARC SETTING



- Arc Selection 40° to Continuous 360°
Adjust From Left Start



EMERALD BAY RESORT

Exuma Island, Bahamas

Over 2000 acres of tropical landscaping, groomed lawns and golf courses surround this first class resort. K-Rain products were used exclusively in all areas.

SOUTHEASTERN IRRIGATION/BERMUDA LANDSCAPE COMPANIES OF LAKE WORTH, FLORIDA INSTALLED THE THE LANDSCAPING AND IRRIGATION SYSTEM.



RCW

HIGH POP

SHRUB

PROPLUS™ FOR RECLAIMED WATER–11003-RCW

A heavy duty rubber cover protects against physical injury. The purple cover positively identifies reclaimed water use and reduces your liability.

FOR MORE INFORMATION ON RCW PRODUCTS, PLEASE SEE PAGES 36 AND 37.

PROPLUS™ 12" HIGH POP–11003-HP

Appropriate for medium-to-large landscape areas, the PROPLUS™ HP provides high-level-accuracy in a riser that pops up over your plant material.

As with all the members of the PROPLUS™ family, the High Pop provides the patented Arc Set, with the arc of rotation clearly indicated at the top. Fully adjustable from 40° to continuous 360° degrees, the system is adjustable prior to installation and during operation.

A ratcheting riser allows easy adjustment of the left start position.

PROPLUS™ SHRUB HEAD–11003-SH

All the features of the PROPLUS in a shrub head model.

Big things come in small packages. That's the scoop on the PROPLUS™ Shrub Head. This rotor is packed with versatility, reliability and proven excellence.

The PROPLUS™ Shrub Head incorporates 2N1 adjustable or continuous rotation. This innovative component in rotor design provides a full range of adjustment from 40° to continuous 360°; reducing inventory and streamlining contractors' back-office operation.

PROPLUS ■ PERFORMANCE DATA

PERFORMANCE			
NOZZLE	PRESSURE PSI	RADIUS FT.	FLOW GPM
#0.5	30	28'	.5
	40	29'	.6
	50	29'	.7
	60	30'	.8
#0.75	30	29'	.7
	40	30'	.8
	50	31'	.9
	60	32'	1.0
#1	30	32'	1.3
	40	33'	1.5
	50	34'	1.6
	60	35'	1.8
#2	30	37'	2.4
	40	40'	2.5
	50	42'	3.0
	60	43'	3.3
#2.5 PRE-INSTALLED	30	38'	2.5
	40	39'	2.8
	50	40'	3.2
	60	41'	3.5
#3	30	38'	3.6
	40	39'	4.2
	50	41'	4.6
	60	42'	5.0
#4	30	43'	4.4
	40	44'	5.1
	50	46'	5.6
	60	49'	5.9
#6	40	45'	5.9
	50	46'	6.0
	60	48'	6.3
	70	49'	6.7
#8	40	42'	8.0
	50	45'	8.5
	60	49'	9.5
	70	50'	10.0

METRIC					
NOZZLE	PRESSURE		RADIUS METERS	FLOW RATE	
	kPa	BARS		L/M	M ³ /H
#0.5	206	2.0	8.5	1.89	.11
	275	3.0	8.8	2.27	.14
	345	3.5	8.8	2.65	.16
	413	4.0	9.1	3.03	.18
#0.75	206	2.0	8.8	2.65	.16
	275	3.0	9.1	3.03	.18
	345	3.5	9.4	3.41	.20
	413	4.0	9.8	3.79	.23
#1	206	2.0	9.8	4.92	.30
	275	3.0	10.1	5.68	.34
	345	3.5	10.4	6.05	.36
	413	4.0	10.7	6.81	.41
#2	206	2.0	11.3	9.08	.54
	275	3.0	12.2	9.46	.56
	345	3.5	12.8	11.35	.68
	413	4.0	13.1	12.49	.75
#2.5 PRE-INSTALLED	206	2.04	11.6	9.46	.57
	275	2.72	11.9	10.60	.64
	345	3.40	12.2	12.11	.73
	413	4.08	12.5	13.25	.79
#3	206	2.0	11.6	13.63	.81
	275	3.0	11.9	15.89	.95
	345	3.5	12.5	17.41	1.04
	413	4.0	12.8	18.92	1.13
#4	206	2.0	13.1	16.65	.99
	275	3.0	13.4	19.30	1.15
	345	3.5	14.0	21.19	1.27
	413	4.0	14.9	22.33	1.33
#6	206	3.0	13.7	22.33	1.33
	275	3.5	14.0	22.71	1.36
	345	4.0	14.6	23.85	1.43
	413	5.0	14.9	25.35	1.52
#8	206	3.0	12.8	30.28	1.81
	275	3.5	13.7	32.12	1.92
	345	4.0	14.8	35.95	2.15
	413	5.0	15.3	37.85	2.27

LOW ANGLE DATA			
NOZZLE	PRESSURE PSI	RADIUS FT.	FLOW GPM
#1	30	22'	1.2
	40	24'	1.7
	50	26'	1.8
	60	28'	2.0
#3	30	29'	3.0
	40	32'	3.1
	50	35'	3.5
	60	37'	3.8
#4	30	31'	3.4
	40	34'	3.9
	50	37'	4.4
	60	38'	4.7
#6	40	38'	6.5
	50	40'	7.3
	60	42'	8.0
	70	44'	8.6

METRIC					
NOZZLE	PRESSURE		RADIUS METERS	FLOW RATE	
	kPa	BARS		L/M	M ³ /H
#1	207	2.04	6.71	4.54	.27
	275	2.72	7.32	6.43	.39
	344	3.40	7.92	6.80	.41
	413	4.08	8.53	7.56	.46
#3	207	2.04	8.84	11.34	.68
	275	2.72	9.75	11.72	.71
	344	3.40	10.67	13.23	.80
	413	4.08	11.58	14.36	.87
#4	207	2.04	9.45	12.85	.78
	275	2.72	10.36	14.74	.89
	344	3.40	11.28	16.63	1.00
	413	4.08	11.58	17.77	1.07
#6	275	2.72	11.58	24.57	1.48
	344	3.40	12.19	27.59	1.76
	413	4.08	12.80	30.24	1.82
	482	4.76	13.41	32.51	1.96

Data represents test results in zero wind. Adjust for local conditions. Radius may be reduced with nozzle retention screw.

SPECIFICATIONS

- Inlet: 3/4" Threaded NPT
- Arc Adjustment Range: 40° to Continuous 360°
- Flow Range: .5 - 10.0 GPM
- Pressure Rating: 20 - 70 PSI
- Precipitation Rate: .06 to .50 Inches Per Hour
(Depending on Spacing and Nozzle Used)
- Overall Height (Popped Down): 7 1/2" / 17" for High Pop
- Recommended Spacing: 28' to 44'
- Radius: 22' to 50'
- Nozzle Trajectory: 26°
- Low Angle Nozzle Trajectory: 12°
- Standard and Low Angle Nozzle: Included
- Riser Height: 5"



FACT

K-RAIN founder Carl Kah, holds over 90 patents specific to the irrigation industry. Notable patents include the reversing mechanism and K-RAIN's arc set indicator.

K-RAIN PROPLUS™ MODEL 11003

The ProPlus is a gear-driven, rotary type sprinkler, capable of covering an area of 22' to 50' (6.7 to 15.3 M) radius at nozzle pressure of 30 to 70 PSI (2.0 to 5.0 bar) with a discharge rate of .5 to 10.0 GPM (1.89 to 37.85 LPM). The ProPlus is supplied with nine (9) numerically coded interchangeable nozzles. Sprinkler nozzle trajectory is 26°. The ProPlus is supplied with four (4) numerically coded interchangeable low angle nozzles. Low angle nozzle trajectory is 12°. The sprinkler has a stainless steel radius adjustment screw.

The ProPlus provides both part and full circle adjustment from 40° to 360°. Sprinkler coverage pattern is indicated by degree graduations and an arrow located on top of the sprinkler, which rotates to correspond with arc selected. True full circle operation by continuous forward rotation is achieved by alignment of the indication arrow with the "360°" position locator marked on the top cover. The sprinkler has a friction-clutch mechanism to allow for 360°+ forward or reverse movement of nozzle turret without damage to the internal gear components. The ProPlus incorporates an "arc memory clutch" feature to allow original arc pattern to be automatically resumed following disturbance of nozzle turret setting. The sprinkler has a minimum of 5-inch (12.7 cm) pop-up stroke and a 3/4-inch female thread inlet.



MODELS

10003	SuperPro
10003-HP	SuperPro 12" High Pop
10003-SH	SuperPro Shrub Head

OTHER OPTIONS: ADD TO PART NUMBER

-CV	Check Valve
-NN	No Nozzle
-RCW	Reclaimed Water Use

SUPERPRO™ 10003

The SUPERPRO™ Rotor with its patented flow control allows you to reduce the distance and flow rate proportionately for even water fall out and better zone performance. When turned off completely the riser stays popped up for quick nozzle changes or adjustments.

Like all K-Rain rotors, the SUPERPRO™ is packed with innovative features: Partial to continuous 360° coverage, an interchangeable nozzle for superior spray patterns, patented Easy Arc Set and Arc Memory Clutch, which returns the rotor to its preset position automatically.



INNOVATIVE FLOW CONTROL

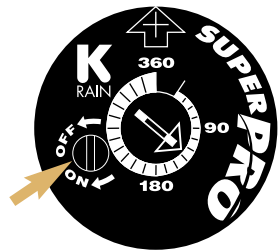

- Reduces distance & flow rate proportionately
- Provides full On/Off control



Scan the code with your smart phone & watch the video.

HOW TO SPECIFY

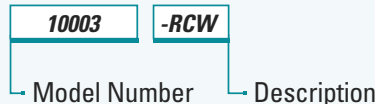

FEATURES/BENEFITS

- Patented Flow Shut-Off – Adjust distance and water flow at the same time. Allows individual heads to be turned off during installation or adjustment—perfect for quick nozzle changes.
- 5" Riser—Perfect for grasses with thick thatch.
- 3/4" Inlet—Replaces all standard rotors.
- Revolutionary Patented Easy Arc Set—Simplified arc set allows for wet or dry adjustment in seconds.
- 2N1 Adjustable or Continuous Rotation—Provides a full range of adjustment from 40° to a continuous full circle.
- Patented Arc Set Degree Markings—Clearly indicates the current watering pattern and simplifies arc set adjustment.
- Arc Memory Clutch—Prevents internal gear damage and returns rotor to its prior setting automatically if nozzle turret is forced past its stop.
- Time Proven Patented Reversing Mechanism—Assures continuous reverse and return...over a 20 year history.
- Ratcheting Riser—Allows for easy adjustment of your left starting position with a simple turn of the riser.
- Rubber Cover—Seals out dirt and increases product durability.
- Wide Selection of Nozzles—Including standard and low angle, provides flexibility in system design.
- Optional Check Valve—Prevents low head drainage.
- Five Year Limited Warranty.



Arc Selection 40° to Continuous 360°
 Adjust From Left Start

SPECIFICATIONS

- Inlet: 3/4" Threaded NPT
- Arc Adjustment Range: 40° to Continuous 360°
- Flow Range: .5 - 10.0 GPM
- Pressure Rating: 20 - 70 PSI
- Precipitation Rate: .05 to .74 Inches Per Hour (Depending on Spacing and Nozzle Used)
- Overall Height (Popped Down): 7 1/2"
- Recommended Spacing: 28' to 44'
- Radius: 26' to 49'
- Nozzle Trajectory: 26°
- Low Angle Nozzle Trajectory: 12°
- Standard and Low Angle Nozzle: Included
- Riser Height: 5"



FACT

K-RAIN'S exclusive patented top arc indication makes their rotors the easiest in the world to adjust.

K-RAIN SUPERPRO™ MODEL 10003

The SuperPro is a gear-driven, rotary type sprinkler, capable of covering an area of 26' to 49' (7.9 to 14.9 M) radius at nozzle pressure of 30 to 70 PSI (2.1 to 4.8 bar) with a discharge rate of .5 to 10.0 GPM (1.89 to 35.96 LPM). The SuperPro has a manual flow shut-off (patent pending). The sprinkler is supplied with nine (9) numerically coded interchangeable nozzles. Sprinkler nozzle trajectory is 26°. The SuperPro is supplied with four (4) numerically coded interchangeable low angle nozzles. Low angle nozzle trajectory is 12°. The SuperPro has a stainless steel radius adjustment screw.

The SuperPro provides both part and full circle adjustment from 40° to continuous 360°. Sprinkler coverage pattern is indicated by degree graduations and an arrow located on top of the sprinkler, which rotates to correspond with arc selected. True full circle operation by continuous forward rotation is achieved by alignment of the indication arrow with the "360°" position locator marked on the top cover. The sprinkler has a friction-clutch mechanism to allow for 360°+ forward or reverse movement of nozzle turret without damage to the internal gear components. The SuperPro incorporates an "arc memory clutch" feature to allow original arc pattern to be automatically resumed following disturbance of nozzle turret setting.



The SUPERPRO has a minimum of 5-inch (12.7 cm) pop-up stroke and a 3/4-inch female thread inlet.

SUPERPRO ■ PERFORMANCE DATA

PERFORMANCE			
NOZZLE	PRESSURE PSI	RADIUS FT.	FLOW GPM
#0.5	30	30'	.45
	40	29'	.5
	50	26'	.6
	60	26'	.7
#0.75	30	32'	.7
	40	32'	.8
	50	33'	.9
	60	33'	1.0
#1	30	30'	1.1
	40	32'	1.3
	50	33'	1.5
	60	33'	1.6
#2	30	38'	2.3
	40	38'	2.5
	50	40'	2.7
	60	42'	3.0
#2.5 PRE-INSTALLED	30	35'	2.5
	40	36'	2.8
	50	37'	3.2
	60	38'	3.6
#3	30	35'	3.4
	40	36'	3.8
	50	38'	4.2
	60	39'	4.8
#4	30	42'	4.1
	40	44'	4.6
	50	45'	5.1
	60	46'	5.7
#6	40	46'	5.8
	50	48'	6.4
	60	49'	7.0
	70	49'	7.5
#8	40	42'	7.5
	50	45'	8.2
	60	48'	9.0
	70	48'	9.5

METRIC					
NOZZLE	PRESSURE		RADIUS METERS	FLOW RATE	
	kPa	BARS		L/M	M ³ /H
#0.5	207	2.1	9.1	1.70	.10
	276	2.8	8.8	1.89	.11
	345	3.4	7.9	2.27	.14
	414	4.1	7.9	2.65	.16
#0.75	207	2.1	9.8	2.65	.16
	276	2.8	9.8	3.03	.18
	345	3.4	10.1	3.41	.20
	414	4.1	10.1	3.79	.23
#1	207	2.1	9.1	4.16	.25
	276	2.8	9.8	4.92	.30
	345	3.4	10.1	5.68	.34
	414	4.1	10.1	6.06	.36
#2	207	2.1	11.6	8.71	.52
	276	2.8	11.6	9.46	.57
	345	3.4	12.2	10.22	.61
	414	4.1	12.8	11.36	.68
#2.5 PRE-INSTALLED	207	2.1	10.7	9.46	.57
	276	2.8	11.0	10.60	.64
	345	3.4	11.3	12.11	.73
	414	4.1	11.6	13.63	.82
#3	207	2.1	10.7	12.87	.77
	276	2.8	11.0	14.38	.86
	345	3.4	11.6	15.90	.95
	414	4.1	11.9	18.17	1.09
#4	207	2.1	12.8	15.52	.93
	276	2.8	13.4	17.41	1.04
	345	3.4	13.7	19.31	1.16
	414	4.1	14.0	21.58	1.29
#6	276	2.8	14.0	21.96	1.32
	345	3.4	14.6	24.23	1.45
	414	4.1	14.9	26.50	1.59
	483	4.8	14.9	28.39	1.70
#8	276	2.8	12.8	28.39	1.70
	345	3.4	13.7	31.04	1.86
	414	4.1	14.6	34.07	2.04
	483	4.8	14.6	35.96	2.16

LOW ANGLE DATA			
NOZZLE	PRESSURE PSI	RADIUS FT.	FLOW GPM
#1	30	26'	1.3
	40	27'	1.5
	50	27'	1.7
	60	28'	1.9
#3	30	29'	2.9
	40	30'	3.3
	50	31'	3.4
	60	33'	4.0
#4	30	28'	4.0
	40	31'	4.7
	50	34'	5.0
	60	36'	6.0
#6	40	30'	6.0
	50	34'	7.0
	60	37'	7.8
	70	38'	8.2

LOW ANGLE DATA, METRIC					
NOZZLE	PRESSURE		RADIUS METERS	FLOW RATE	
	kPa	BARS		L/M	M ³ /H
#1	207	2.1	7.9	4.92	.30
	276	2.8	8.2	5.68	.34
	345	3.4	8.2	6.44	.39
	414	4.1	8.5	7.19	.43
#3	207	2.1	8.8	10.98	.66
	276	2.8	9.1	12.49	.75
	345	3.4	9.4	12.87	.77
	414	4.1	10.1	15.14	.91
#4	207	2.1	8.5	15.14	.91
	276	2.8	9.4	17.79	1.07
	345	3.4	10.4	18.93	1.14
	414	4.1	11.0	22.71	1.36
#6	207	2.8	9.1	22.71	1.36
	276	3.4	10.4	26.50	1.59
	345	4.1	11.3	29.53	1.77
	414	4.8	11.6	31.04	1.86

Data represents test results in zero wind. Adjust for local conditions. Radius may be reduced with nozzle retention screw.



THE ROYAL MIRAGE

United Arab Emirates

One of the premier resorts in the UAE, the Royal Mirage is located on a 1km by 5km lush parcel on the Arabian Gulf. Local irrigation and landscape contractor, Desert Landscape Company, installed K-Rain rotors and sprinklers throughout the property.

The maintenance free integrity and sturdy construction of the product were the keys to choosing K-Rain for this project.

London-based Fitco Industries Ltd., distributes K-Rain products throughout the Middle East and supports their distributors with ongoing warranty and technical advice.

PHOTOS COURTESY OF FITCO INDUSTRIES, LTD.



MODELS

15003	ProCom
15003-SS	ProCom Stainless Steel

OTHER OPTIONS: ADD TO PART NUMBER

-LA	Low Angle Nozzle
-NN	No Nozzle
-RCW	Reclaimed Water Use

PROCOM™ 15003

Heavy-duty commercial grade features.

The PROCOM™ Rotor, packed with the superior heavy duty components of a sports turf rotor, is the answer to all of your commercial and industrial needs.

Available in plastic or the ever popular stainless steel, this product comes with nine nozzles and the shut-off feature (patent pending) included.



FEATURES/BENEFITS

- Flow Shut-Off (patented)—Allows individual heads to be turned off during installation or adjustment—perfect for quick nozzle changes.
- 3/4" Inlet—Replaces all standard rotors.
- Revolutionary Patented Easy Arc Set—Simplified arc set allows for wet or dry adjustment in seconds.
- 2N1 Adjustable or Continuous Rotation—Provides a full range of adjustment from 40° to a continuous full circle.
- Patented Arc Set Degree Markings—Clearly indicates the current watering pattern and simplifies arc set adjustment.
- Arc Memory Clutch—Prevents internal gear damage and returns rotor to its prior setting automatically if nozzle turret is forced past its stop.
- Time Proven Patented Reversing Mechanism—Assures continuous reverse and return...over a 20 year history.
- Wide Selection of Nozzles—Including standard and low angle, provides flexibility in system design.
- Heavy Duty Rubber Cover—Seals out dirt, increases product durability and protects from injury.
- Rubber Mud Guard—Allows sprinkler to be installed below grade.
- Factory Installed Check Valve—Prevents low head drainage.
- Five Year Limited Warranty.

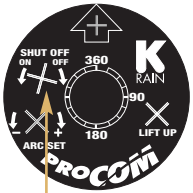

Patented Flow Shut-Off allows you to stop the flow right at the head.

HOW TO SPECIFY

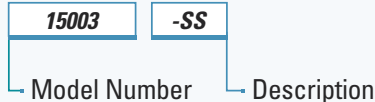

EASY ARC SETTING



- Arc Selection 40° to Continuous 360°
Adjust From Left Start

SPECIFICATIONS

- Inlet: 3/4" Threaded NPT
- Arc Adjustment Range: 40° to Continuous 360°
- Flow Range: .5 - 10.0 GPM
- Pressure Rating: 20 - 90 PSI
- Precipitation Rate: .06 to .50 Inches Per Hour (Depending on Spacing and Nozzle Used)
- Overall Height (Popped Down): 8 3/4"
- Recommended Spacing: 28' to 46'
- Radius: 22' to 50'
- Nozzle Trajectory: 26°
- Low Angle Nozzle Trajectory: 12°
- Standard and Low Angle Nozzle: Included
- Riser Height: 4"



FACT

Having grown from one employee in 1974, K-RAIN currently employs a diverse workforce of over 300 people.

K-RAIN PROCOM™ MODEL 15003

The ProCom is a gear-driven, rotary type sprinkler, capable of covering an area of 22' to 50' (6.7 to 15.3 M) radius at nozzle pressure of 20 to 90 PSI (1.4 to 6.2 bar) with a discharge rate of .5 to 10 GPM (1.89 to 37.85 LPM). The ProCom has a patented manual flow shut-off. The sprinkler is supplied with nine (9) numerically coded interchangeable nozzles. Nozzle trajectory is 26°. The ProCom is supplied with four (4) numerically coded interchangeable low angle nozzles. Low angle nozzle trajectory is 12°. The ProCom has a stainless steel radius adjustment screw.

The ProCom provides both part and full circle adjustment from 40° to continuous 360°. Coverage pattern is indicated by degree graduations and an arrow located on top of the sprinkler, which rotates to correspond with arc selected. True full circle operation by continuous forward rotation is achieved by alignment of the indication arrow with the "360°" position locator marked on the top cover. The rotor has a friction-clutch mechanism to allow for 360°+ forward or reverse movement of nozzle turret without damage to the internal gear components. The ProCom incorporates an "arc memory clutch" feature to allow original arc pattern to be automatically resumed following disturbance of nozzle turret setting.



The PROCOM has a minimum of 4-inch (10 cm) pop-up stroke and a 3/4-inch female thread inlet.

The PROCOM is available in stainless steel.

PROCOM ■ PERFORMANCE DATA

PERFORMANCE			
NOZZLE	PRESSURE PSI	RADIUS FT.	FLOW GPM
#0.5	30	28'	.5
	40	29'	.6
	50	29'	.7
	60	30'	.8
#0.75	30	29'	.7
	40	30'	.8
	50	31'	.9
	60	32'	1.0
#1	30	32'	1.3
	40	33'	1.5
	50	34'	1.6
	60	35'	1.8
#2	30	37'	2.4
	40	40'	2.5
	50	42'	3.0
	60	43'	3.3
#2.5 PRE-INSTALLED	30	38'	2.5
	40	39'	2.8
	50	40'	3.2
	60	41'	3.5
#3	30	38'	3.6
	40	39'	4.2
	50	41'	4.6
	60	42'	5.0
#4	30	43'	4.4
	40	44'	5.1
	50	46'	5.6
	60	49'	5.9
#6	40	45'	5.9
	50	46'	6.0
	60	48'	6.3
	70	49'	6.7
#8	40	42'	8.0
	50	45'	8.5
	60	49'	9.5
	70	50'	10.0

METRIC					
NOZZLE	PRESSURE		RADIUS METERS	FLOW RATE	
	kPa	BARS		L/M	M ³ /H
#0.5	206	2.0	8.5	1.89	.11
	275	3.0	8.8	2.27	.14
	345	3.5	8.8	2.65	.16
	413	4.0	9.1	3.03	.18
#0.75	206	2.0	8.8	2.65	.16
	275	3.0	9.1	3.03	.18
	345	3.5	9.4	3.41	.20
	413	4.0	9.8	3.79	.23
#1	206	2.0	9.8	4.92	.14
	275	3.0	10.1	5.68	.18
	345	3.5	10.4	6.05	.20
	413	4.0	10.7	6.81	.23
#2	206	2.0	11.3	9.08	.54
	275	3.0	12.2	9.46	.56
	345	3.5	12.8	11.35	.68
	413	4.0	13.1	12.49	.75
#2.5 PRE-INSTALLED	206	2.04	11.6	9.46	.57
	275	2.72	11.9	10.60	.64
	345	3.40	12.2	12.11	.73
	413	4.08	12.5	13.25	.79
#3	206	2.0	11.6	13.63	.75
	275	3.0	11.9	15.89	.95
	345	3.5	12.5	17.41	1.04
	413	4.0	12.8	18.92	1.13
#4	206	2.0	13.1	16.65	.99
	275	3.0	13.4	19.30	1.15
	345	3.5	14.0	21.19	1.27
	413	4.0	14.9	22.33	1.33
#6	275	3.0	13.7	22.33	1.33
	345	3.5	14.0	22.71	1.36
	413	4.0	14.6	23.85	1.43
	483	5.0	14.9	25.35	1.52
#8	275	3.0	12.8	30.28	1.81
	345	3.5	13.7	32.12	1.92
	413	4.0	14.8	35.95	2.15
	483	5.0	15.3	37.85	2.27

LOW ANGLE DATA			
NOZZLE	PRESSURE PSI	RADIUS FT.	FLOW GPM
#1	30	22'	1.2
	40	24'	1.7
	50	26'	1.8
	60	28'	2.0
#3	30	29'	3.0
	40	32'	3.1
	50	35'	3.5
	60	37'	3.8
#4	30	31'	3.4
	40	34'	3.9
	50	37'	4.4
	60	38'	4.7
#6	40	38'	6.5
	50	40'	7.3
	60	42'	8.0
	70	44'	8.6

METRIC					
NOZZLE	PRESSURE		RADIUS METERS	FLOW RATE	
	kPa	BARS		L/M	M ³ /H
#1	207	2.04	6.71	4.54	.34
	275	2.72	7.32	6.43	.39
	344	3.40	7.92	6.80	.41
	413	4.08	8.53	7.56	.46
#3	207	2.04	8.84	11.34	.68
	275	2.72	9.75	11.72	.71
	344	3.40	10.67	13.23	.80
	413	4.08	11.58	14.36	.87
#4	207	2.04	9.45	12.85	.78
	275	2.72	10.36	14.74	.89
	344	3.40	11.28	16.63	1.00
	413	4.08	11.58	17.77	1.07
#6	275	2.72	11.58	24.57	1.68
	344	3.40	12.19	27.59	1.66
	413	4.08	12.80	30.24	1.82
	482	4.76	13.41	32.51	1.96

Data represents test results in zero wind. Adjust for local conditions. Radius may be reduced with nozzle retention screw.



ROTORS

SPRAYS & NOZZLE

ELECTRIC VALVES

CONTROLLERS

INDEX VALVES / RCW

CHARTS

MODELS

14003	ProSport Plastic
14003-SS	ProSport Stainless Steel
14003-BSP	ProSport w/BSP Thread
14003-BSP-SS	ProSport Stainless Steel w/BSP Thread
14053	ProSport High Speed Plastic
14053-SS	ProSport High Speed Stainless Steel
14053-BSP	ProSport High Speed w/BSP Thread
14053-BSP-SS	ProSport High Speed Stainless Steel w/BSP Thread

OTHER OPTIONS: ADD TO PART NUMBER

-NN	No Nozzle
-RCW	Reclaimed Water Use

PROSPORT™ 14003

The PROSPORT™ is K-Rain's next generation of professional rotors, designed specifically for sports turf applications with head spacing from 40 to 65 feet.

The PROSPORT™ comes standard with a unique triple nozzle. The triple nozzle configuration consists of a primary nozzle for long distance and two secondary nozzles for mid-range and short distance coverage. This nozzle design provides even water distribution from 45 to 77 feet.

PROSPORT™ comes in a high speed version, ideal for quick wet downs and dust control.



FEATURES/BENEFITS

- Revolutionary Patented Easy Arc Set—Simplified arc set allows for wet or dry adjustment in seconds.
- Triple Nozzle Configuration—Ensures even distribution of water.
- 2N1 Adjustable or Continuous Rotation—Provides a full range of adjustment from 40° to a continuous full circle.
- Patented Arc Set Degree Markings—Clearly indicates the current watering pattern and simplifies arc set adjustment.
- Arc Memory Clutch—Prevents internal gear damage and returns rotor to its prior setting automatically if nozzle turret is forced past its stop.
- Time Proven Patented Reversing Mechanism—Assures continuous reverse and return...over a 20 year history.
- Heavy Duty Rubber Cover / Rubber Mud Guard—Protects against physical injury and reduces liability, allows sprinkler to be installed below grade.
- Factory Installed Check Valve—Prevents low head drainage.
- Five Year Limited Warranty.

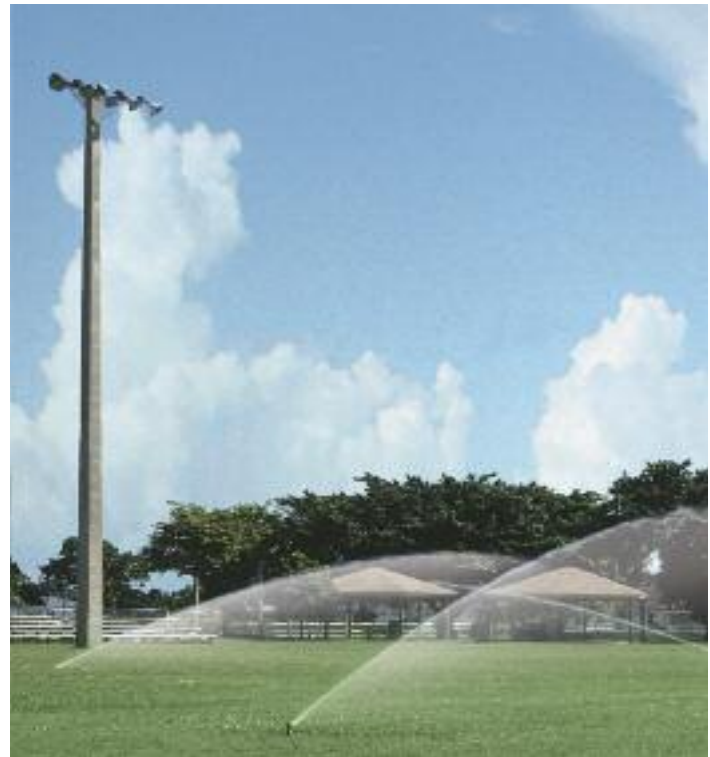

HOW TO SPECIFY

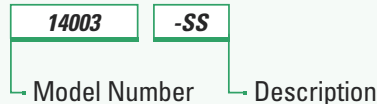

EASY ARC SETTING



- Arc Selection 40° to Continuous 360°
Adjust From Left Start

SPECIFICATIONS

- Inlet: 1" Threaded NPT Domestic 1" BSP: International
- Arc Adjustment Range: 40° to Continuous 360°
- Flow Range: 5.9 - 32.5 GPM
- Pressure Rating: 40 - 90 PSI
- Precipitation Rate: .3 to .78 Inches Per Hour (Depending on Spacing and Nozzle Used)
- Overall Height (Popped Down): 9 1/2"
- Recommended Spacing: 40' to 65'
- Radius: 45' to 77'
- Nozzle Trajectory: 26°
- Riser Height: 4"



FACT

K-RAIN'S new product concepts are developed, manufactured and tested in its Riviera Beach, Florida manufacturing facility. Harsh sun and sand conditions provide a natural proving ground for new ideas.

K-RAIN PROSPORT™ MODEL 14003

The ProSport is a gear-driven rotor capable of covering an area of 45' to 77' (13.7 to 23.5 M) radius at nozzle pressure of 40 to 90 PSI (2.76 to 6.21 bar) with a discharge rate of 5.9 to 32.5 GPM (22.3 to 123.0 LPM).

The ProSport is supplied with six (6) numerically coded interchangeable nozzles. Nozzle trajectory is 26° and incorporates three (3) discharge ports. The rotor has a stainless steel radius adjustment screw.

The ProSport provides both part and full circle adjustment from 40° to 360°. Coverage pattern is indicated by degree graduations and an arrow located on top of the sprinkler, which rotates to correspond with arc selected. True full circle operation by continuous rotation is provided by alignment of the indication arrow with the "360°" position locator marked on the top cover.







The rotor has a friction-clutch mechanism to allow for 360°+ forward or reverse movement of nozzle turret without damage to the internal gear components. The ProSport incorporates an "arc memory clutch" feature to allow original arc pattern to be automatically resumed following disturbance of nozzle turret setting.







The ProSport has a minimum of 4-inch (10 cm) pop-up stroke. The sprinkler has a 1-inch female thread inlet.















UNIVERSITY OF MARYLAND, BYRD STADIUM FOOTBALL FIELD

PROSPORT ■ PERFORMANCE DATA

MODEL 14003 PERFORMANCE			
NOZZLE	PRESSURE PSI	RADIUS FT.	FLOW GPM
	40	45'	5.1
	50	47'	5.9
	60	47'	6.5
	70	49'	7.1
	50	53'	10.6
	60	53'	11.8
	70	53'	12.6
	80	55'	13.5
	50	57'	13.0
	60	59'	14.2
	70	59'	15.4
	80	63'	16.5
	60	65'	18.9
	70	67'	20.5
	80	69'	21.9
	90	71'	23.2
	60	67'	22.8
	70	71'	24.8
	80	75'	26.5
	90	77'	26.8
	60	67'	23.7
	70	69'	25.6
	80	69'	27.5
	90	71'	29.2

MODEL 14003 METRIC					
NOZZLE	PRESSURE		RADIUS METERS	FLOW RATE	
	kPa	BARS		L/M	M ³ /H
	276	2.76	13.7	19.3	1.16
	345	3.45	14.3	22.3	1.34
	414	4.14	14.3	24.6	1.48
	483	4.83	14.9	26.9	1.61
	345	3.45	16.2	40.1	2.41
	414	4.14	15.9	44.3	2.66
	483	4.83	16.2	47.7	2.86
	552	5.52	16.8	51.1	3.06
	345	3.45	17.4	49.2	2.95
	414	4.14	18.0	53.8	3.23
	483	4.83	18.0	58.3	3.50
	552	5.52	19.2	62.5	3.75
	414	4.14	19.8	71.5	4.29
	483	4.83	20.4	77.6	4.66
	552	5.52	21.0	82.9	4.97
	621	6.21	21.6	87.8	5.27
	414	4.14	20.4	86.3	5.18
	483	4.83	21.6	93.9	5.63
	552	5.52	22.9	100.3	6.02
	621	6.21	23.5	101.4	6.08
	414	4.14	20.4	89.7	5.38
	483	4.83	21.0	96.9	5.81
	552	5.52	21.0	104.1	6.25
	621	6.21	21.6	110.5	6.63

MODEL 14053 PERFORMANCE			
NOZZLE	PRESSURE PSI	RADIUS FT.	FLOW GPM
	40	43'	5.9
	50	44'	6.2
	60	45'	6.4
	70	45'	7.6
	50	49'	10.6
	60	53'	11.5
	70	53'	13.3
	80	54'	14.0
	50	52'	12.4
	60	54'	13.6
	70	56'	14.6
	80	58'	15.9
	60	56'	19.8
	70	58'	21.2
	80	59'	22.8
	90	60'	24.4
	60	59'	22.4
	70	66'	25.7
	80	67'	27.8
	90	68'	29.9
	60	60'	25.2
	70	72'	28.5
	80	73'	30.8
	90	75'	32.5

MODEL 14053 METRIC					
NOZZLE	PRESSURE		RADIUS METERS	FLOW RATE	
	kPa	BARS		L/M	M ³ /H
	276	2.76	13.11	22.3	1.34
	345	3.45	13.41	23.47	1.14
	414	4.14	13.72	24.22	1.45
	483	4.83	13.72	28.77	1.73
	345	3.45	14.94	40.12	2.41
	414	4.14	15.85	44.28	2.66
	483	4.83	16.15	50.34	3.02
	552	5.52	16.46	52.99	3.18
	345	3.45	15.85	46.93	2.82
	414	4.14	16.46	58.67	3.52
	483	4.83	17.07	55.26	3.32
	552	5.52	17.68	60.18	3.61
	414	4.14	17.07	66.24	3.97
	483	4.83	17.68	71.54	4.29
	552	5.52	17.98	78.73	4.72
	621	6.21	18.29	82.14	4.93
	414	4.14	17.98	84.78	5.09
	483	4.83	20.12	97.28	5.84
	552	5.52	20.42	105.23	6.31
	621	6.21	20.73	113.18	6.79
	414	4.14	18.29	95.38	5.72
	483	4.83	21.95	107.88	6.47
	552	5.52	22.25	116.59	7.00
	621	6.21	22.86	123.03	7.38

Data represents test results in zero wind. Adjust for local conditions. Radius may be reduced with nozzle retention screw.

MODELS

73001	3" Pop-Up
74001	4" Pop-Up
76001	6" Pop-Up
71201	12" Pop-Up

OTHER OPTIONS: ADD TO PART NUMBER

-RCW	Reclaimed Water Use
-CV	Check Valve

SPECIFICATIONS

- Pressure Rating: 20 - 50 PSI
- Flow Range: .5 - 4.6 GPM
- Precipitation Rate: .4 - 1.91 in./hr
- Inlet: 1/2" NPT Female Thread

FEATURES/BENEFITS

- Available in 3", 4", 6" and 12" Models—Provides flexibility in system design.
- Accepts Male Threaded Nozzles (Except Model 74001-M)
- Stainless Steel Retraction Spring—Provides reliable retraction of the riser in all soil conditions.
- Ratcheting Riser—Allows for easy pattern alignment by turning the riser.
- Heavy Duty Wiper Seal—Ensures leak free, full pop-up operation even under low-pressure situations.
- Optional Purple Cap for Reclaimed Water use—Highly visible for identification of reclaimed water systems reducing liability.
- Two Year Limited Warranty.

K-SPRAY SERIES

K-Spray pop-ups are ideal for watering smaller areas, ground cover and shrub areas.

FOR MORE INFORMATION ON RCW PRODUCTS, PLEASE SEE PAGES 36 AND 37.



HOW TO SPECIFY



FOR NOZZLE SELECTION, PLEASE SEE PAGES 28-31.



SHRUB ADAPTER
PART # PSA



SPRAY HEAD CHECK VALVES PART # 53426

(OPTIONAL)



MODELS

RPS-2	2" Narrow Profile Spray Body
RPS-4	4" Narrow Profile Spray Body

NARROW PROFILE SPRAYS

K-Rain's RPS pop-up spray heads are ideal for watering smaller areas, ground cover and shrub areas.

RPS pop-up sprays are built with the contractor in mind. With the narrow profile, replacement is effortless. The RPS Spray is the only narrow profile spray with a co-molded wiper seal. The co-molded wiper seal ensures proper operation year after year with minimal flow by.



FOR NOZZLE SELECTION, PLEASE SEE PAGES 28-31.

FEATURES/BENEFITS

- Available in 2" and 4" Models—Provides flexibility in system design.
- Accepts Female Threaded Nozzles
- Stainless Steel Retraction Spring—Provides reliable retraction of the riser in all soil conditions.
- Ratcheting Riser—Allows for easy pattern alignment by turning the riser.
- Co-Molded Wiper Seal – Ensures leak free, full pop-up operation even under low-pressure situations.
- Narrow Profile Body – Easy to retrofit with existing systems.
- Two Year Limited Warranty.



CO-MOLDED WIPER SEAL



CO-MOLDED WIPER SEAL

K-Rain's co-molded wiper seal reduces flow by-pass at start up and provides durability for longer life.

SPECIFICATIONS

- Pressure Rating: 20 - 50 PSI
- Flow Range: .5 - 4.6 GPM
- Precipitation Rate: .3 - 4.0 in./hr
- Inlet: 1/2" NPT Female Thread

HOW TO SPECIFY

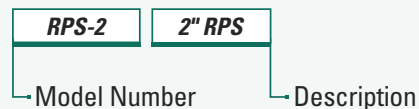

MODELS

78002	2" Pop-Up
78003	3" Pop-Up
78004	4" Pop-Up
78006	6" Pop-Up
78012	12" Pop-Up

OTHER OPTIONS: ADD TO PART NUMBER

-CV	Check Valve
-PR	Pressure Regulator (4, 6 & 12 inch models only)
-RCW	Reclaimed Water Use

SPECIFICATIONS

- Pressure Rating: 20 - 70 PSI
- Flow-by: 0 at 8 psi (0.6 bar) or greater; 0.10 GPM otherwise
- Overall Body Height:

78002 - 4"	78006 - 9 3/8"
78003 - 4 7/8"	78012 - 16"
78004 - 6"	
- Precipitation Rate: .4 - 4 in./hr
- Inlet: 1/2" NPT Female Thread

FEATURES/BENEFITS

- Co-Molded Wiper Seal—Ensures a leak free, full pop-up operation even under low-pressure situations. Cartridge design allows for easy removal and cleaning. Treated with UV inhibitors for long life. Seal is microbe resistant to reduce degradation and stick-ups.
- Accepts Female Threaded Nozzles
- Ratcheting Riser—Permits quick, easy alignment of spray pattern.
- Heavy-Duty Retraction Spring—Strongest spring in the industry for positive retraction in all soil conditions.
- Side and Bottom Inlets—On 6" and 12" models.
- Wide Selection of Sizes—Available in 2", 3", 4", 6" and 12" models.
- Pre-Installed Flush Cap
- Optional In-stem Pressure Regulator available for 4", 6" and 12" models
- Five Year Limited Warranty.



PRO-S SPRAYS

K-Rain introduces the new Pro-S, a rugged, contractor-friendly spray line. Available in 2", 3", 4", 6" and 12" pop-up heights, the Pro-S spray is designed to be compatible with *all* standard female-threaded nozzles.

FOR NOZZLE SELECTION, PLEASE SEE PAGES 28-31.

CHECK VALVE
PART #P53428
(OPTIONAL)



RUGGED CONSTRUCTION

The K-Rain Pro-S line of sprays is distinguished by its robust construction, rugged body and cap, co-molded seal and heavy-duty retraction spring.

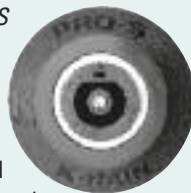

CO-MOLDED WIPER SEAL

Ensures a leak free, full pop-up operation even under low-pressure situations. Unique cartridge design featuring microbe-resistant durable material prevents degradation and stick-ups.



Pre-installed flush cap.

Male threaded body is compatible with all standard female nozzles.

HOW TO SPECIFY

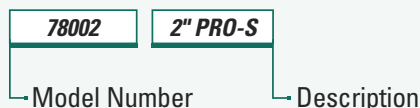

MODELS

RN100-ADJ	Adjustable Rotary Nozzle – 8'-14' (Green)
RN200-ADJ	Adjustable Rotary Nozzle – 14' - 21' (Blue)
RN300-ADJ	Adjustable Rotary Nozzle – 22' - 28' (Red)



SAVES WATER!
Uses up to 30% less water!



Scan the code, watch the video.

ADJUSTABLE FROM 80° TO 360° IN ONE NOZZLE!

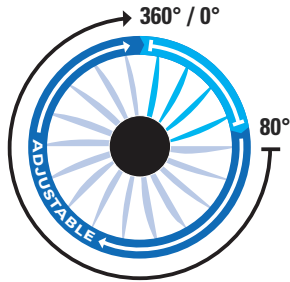

K-RAIN ADJUSTABLE ROTARY NOZZLES

K-rain's Rotary Nozzles, designed to fit into a standard pop-up spray head, provide increased uniform coverage over conventional fixed pattern spray nozzles while delivering matched precipitation.

The highly efficient water delivery reduces soil erosion and runoff, saving water and money. Rotary Nozzles are the perfect solution for low water pressure areas. They are designed to operate at lower pressure while still delivering precise, even coverage.

ADJUSTING THE ARC



The unique Adjustment tool allows for easy adjustment of the pattern while the system is on and provides a clear view of the setting alignment.

FEATURES/BENEFITS

- Adjustable from 80° to 360°
- Female Thread
- Matched Precipitation—Across every arc and radius
- Low Precipitation Rate—Reduces run off
- Low Flow Rate—Less material, fewer zones
- 25% Radius Reduction—Patented flow control, no tools required
- Unique Speed Control—Maintains speed of rotation over varying pressure ranges
- Multiple Stream Technology—Provides improved wind resistance
- Flexible Usage—Any pattern can be combined in the same zone with matched precipitation
- Large Filter—Prolongs product life
- System Flexibility—Can be Installed on the same zone with rotors
- Two Year Limited Warranty

SPECIFICATIONS

RN100-ADJ (Green Nozzle)

- Recommended Spacing: 8' – 14'
- Pressure Rating: 25 – 50 PSI
- Precipitation Rate: .40 to .48 in/hr (depending on head spacing)

RN200-ADJ (Blue Nozzle)

- Recommended Spacing: 14' – 21'
- Pressure Rating: 25 – 50 PSI
- Precipitation Rate: .39 to .40 in/hr (depending on head spacing)

RN300-ADJ (Red Nozzle)

- Recommended Spacing: 22' – 28'
- Pressure Rating: 25 – 50 PSI
- Precipitation Rate: .41 to .47 in/hr (depending on head spacing)

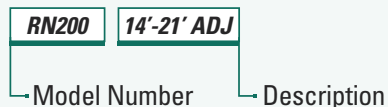

HOW TO SPECIFY







ADJUSTABLE ROTARY NOZZLES PERFORMANCE METRIC



RN100-ADJ (GREEN NOZZLE)

ARC	PRESSURE (PSI)	RADIUS (FT.)	FLOW (GPM)	PRECIP IN/HR		PRESSURE (kPa / BAR)	RADIUS (M)	FLOW (LM)	PRECIP MM/HR	
				■	▲				■	▲
90° 	30	12	0.18	0.46	0.53	2.07	3.66	0.68	9	10
	40	13	0.19	0.44	0.51	2.76	3.96	0.72	10	12
	50	14	0.26	0.48	0.56	3.45	4.27	0.98	11	13
180° 	30	12	0.35	0.46	0.53	2.07	3.66	1.32	10	12
	40	13	0.39	0.44	0.51	2.76	3.96	1.48	11	12
	50	14	0.52	0.48	0.56	3.45	4.27	1.97	12	14
360° 	30	12	0.69	0.46	0.53	2.07	3.66	2.61	10	12
	40	13	0.77	0.44	0.51	2.76	3.96	2.91	11	12
	50	14	0.99	0.40	0.56	3.45	4.27	3.75	12	14

RN200-ADJ (BLUE NOZZLE)

ARC	PRESSURE (PSI)	RADIUS (FT.)	FLOW (GPM)	PRECIP IN/HR		PRESSURE (kPa / BAR)	RADIUS (M)	FLOW (LM)	PRECIP MM/HR	
				■	▲				■	▲
90° 	30	17	0.31	0.39	0.45	2.07	5.18	1.17	9	10
	40	19	0.40	0.40	0.46	2.76	5.79	1.51	10	12
	50	21	0.44	0.40	0.46	3.45	6.40	1.67	11	13
180° 	30	17	0.59	0.39	0.45	2.07	5.18	2.23	10	12
	40	19	0.75	0.40	0.46	2.76	5.79	2.84	11	12
	50	21	0.85	0.40	0.46	3.45	6.40	3.22	12	14
360° 	30	17	1.18	0.39	0.45	2.07	5.18	4.47	10	12
	40	19	1.49	0.40	0.46	2.76	5.79	5.64	11	12
	50	20	1.66	0.40	0.46	3.45	6.40	6.28	12	14

RN300-ADJ (RED NOZZLE)

ARC	PRESSURE (PSI)	RADIUS (FT.)	FLOW (GPM)	PRECIP IN/HR		PRESSURE (kPa / BAR)	RADIUS (M)	FLOW (LM)	PRECIP MM/HR	
				■	▲				■	▲
90° 	30	28	0.70	0.41	0.48	2.07	8.53	2.65	9	10
	40	28	0.80	0.42	0.49	2.76	8.56	3.03	10	12
	50	28	0.90	0.47	0.55	3.45	8.53	3.41	11	13
180° 	30	27	1.50	0.41	0.48	2.07	8.23	5.68	10	12
	40	27	1.60	0.42	0.49	2.76	8.23	6.06	11	12
	50	27	1.80	0.47	0.55	3.45	8.23	6.81	12	14
360° 	30	26	2.90	0.41	0.48	2.07	7.92	10.98	10	12
	40	27	3.20	0.42	0.49	2.76	8.23	12.11	11	12
	50	27	3.60	0.47	0.55	3.45	8.23	13.63	12	14

K-Rain's KV Male and KVF Female Adjustable Nozzles have a superior spray pattern that ensures proper precipitation rates throughout the adjustment. Extra long filters provide longer time between cleanings.

K-Rain's Pressure Compensating Tree Bubblers provide an effective, low application rate for plant life and soil conditions requiring moderate watering and outstanding coverage.

KV NOZZLES

K-Rain's KV Adjustable Nozzles have a MALE thread configuration to fit K-Rain K-Spray bodies.



MODELS

KV Nozzles

KV-8	8' Spray, Green
KV-10	10' Spray, Blue
KV-12	12' Spray, Brown
KV-15	15' Spray, Black
KV-17	17' Spray, Gray

KVF NOZZLES

K-Rain's KVF Adjustable Nozzles have a FEMALE thread configuration to fit RPS and PRO-S spray bodies and 4" K-Spray 74001-M.



MODELS

KVF Nozzles

KVF - 8	8' Spray, Green
KVF - 10	10' Spray, Blue
KVF - 12	12' Spray, Brown
KVF - 15	15' Spray, Black
KVF - 17	17' Spray, Gray

FIXED PATTERNED FEMALE NOZZLES

K-Rain's Matched Precipitation Female Nozzles are Compatible with all Available Male Threaded Bodies.

- Color-Coded—for easy identification.
- Four Distances plus Eight Fixed Patterns—provides an array of system configurations.
- Matched Precipitation—for even water distribution



MODELS

Female Nozzles

FN - 8	8' Spray, Green
FN - 10	10' Spray, Blue
FN - 12	12' Spray, Brown
FN - 15	15' Spray, Black

See pages 30 & 31 for available fixed nozzle patterns.

K-RAIN'S PRESSURE COMPENSATING TREE BUBBLERS

K-Rain's pressure compensating bubblers release water at a slower rate than conventional sprays. Perfect for controlled, gentle irrigation of trees, flowers and shrub areas.

- Low flow rates—allow water to be absorbed slowly
- Reduces runoff
- Maintains even flow



MODELS

Tree Bubblers



TB-05	Tree Bubbler – 0.5 GPM
TB-10	Tree Bubbler – 1.0 GPM
TB-20	Tree Bubbler – 2.0 GPM
TB-ADJ	Tree Bubbler – Adjustable

K-RAIN VARIABLE ARC NOZZLES





PERFORMANCE SPECIFICATIONS KV MALE THREAD NOZZLES

ARC	PRESSURE (PSI)		8' GREEN		10' BLUE		12' BROWN		15' BLACK		17' GRAY-KV ONLY					
			Radius (Ft)	Flow (GPM)	Radius (Ft)	Flow (GPM)	Radius (Ft)	Flow (GPM)	Radius (Ft)	Flow (GPM)	Radius (Ft)	Flow (GPM)				
90	20	7		0.32	12		0.7	12		1.1	15		1.3	18		1.7
	30	8		0.35	12		1.1	13		1.3	17		1.6	18		1.8
	40	8		0.39	13		1.4	14		1.5	18		1.8	19		2.0
	50	9		0.42	14		1.5	15		1.7	19		2.0	20		2.2
180	20	7		0.80	11		1.4	11		1.6	14		1.8	17		1.9
	30	8		0.90	11		1.6	12		1.8	15		2.3	18		2.4
	40	8		0.98	12		1.8	13		2.2	16		2.6	19		2.6
	50	9		1.05	13		2.0	14		2.4	18		2.8	19		2.9
270	20	7		1.17	10		1.7	11		1.9	14		2.7	16		2.9
	30	8		1.24	10		2.0	12		2.4	15		3.2	17		3.4
	40	8		1.31	11		2.3	12		2.6	16		3.6	18		4.0
	50	9		1.53	12		2.6	13		3.0	16		4.0	18		4.5
360	20	7		1.86	10		2.2	11		2.8	13		3.4	15		3.5
	30	8		2.03	10		2.7	12		3.1	15		4.2	17		4.4
	40	8		2.19	11		3.0	12		3.5	15		4.7	17		4.9
	50	9		2.30	12		3.5	13		3.9	16		5.3	18		5.4





METRIC

ARC	PRESSURE (kPa BARS)		8' GREEN		10' BLUE		12' BROWN		15' BLACK		17' GRAY-KV ONLY						
			Radius (M)	Flow (L/M)	Radius (M)	Flow (L/M)	Radius (M)	Flow (L/M)	Radius (M)	Flow (L/M)	Radius (M)	Flow (L/M)					
90	138	1.38	2.1		1.2	3.7		2.6	3.7		4.2	4.6		4.9	3.7		2.6
	207	2.07	2.4		1.3	3.7		4.0	4.0		4.9	5.2		6.1	5.5		6.8
	276	2.76	2.4		1.5	4.0		5.3	4.3		5.7	5.5		6.8	5.8		7.6
	345	3.45	2.7		1.6	4.3		5.7	4.6		6.4	5.8		7.6	6.1		8.3
180	138	1.38	2.1		3.0	3.4		5.3	3.4		6.1	4.3		6.8	5.2		7.2
	207	2.07	2.4		3.4	3.4		6.1	3.7		6.8	4.6		8.7	5.5		9.1
	276	2.76	2.4		3.7	3.7		6.8	4.0		8.3	4.9		9.8	5.8		9.8
	345	3.45	2.7		4.0	4.0		7.6	4.3		9.1	5.5		10.6	5.8		11.0
270	138	1.38	2.1		4.4	3.0		6.4	3.4		7.2	4.3		10.2	4.9		11.0
	207	2.07	2.4		4.7	3.0		7.6	3.7		9.1	4.6		12.1	5.2		12.9
	276	2.76	2.4		5.0	3.4		8.7	3.7		9.8	4.9		13.6	5.5		15.1
	345	3.45	2.7		5.8	3.7		9.8	4.0		11.4	4.9		15.1	5.5		17.0
360	138	1.38	2.1		7.0	3.0		8.3	3.4		10.6	4.0		12.9	4.6		13.2
	207	2.07	2.4		7.7	3.0		10.2	3.7		11.7	4.6		15.9	5.2		16.7
	276	2.76	2.7		8.3	3.4		11.4	3.7		13.2	4.6		17.8	5.2		18.5
	345	3.45	2.7		8.7	3.7		13.2	4.0		14.8	4.9		20.1	5.5		20.4

PERFORMANCE SPECIFICATIONS KVF FEMALE THREAD NOZZLES

ARC	PRESSURE (PSI)		8' GREEN		10' BLUE		12' BROWN		15' BLACK		17' GRAY-KV ONLY					
			Radius (Ft)	Flow (GPM)	Radius (Ft)	Flow (GPM)	Radius (Ft)	Flow (GPM)	Radius (Ft)	Flow (GPM)	Radius (Ft)	Flow (GPM)				
90	20	7		0.32	9		0.40	10		0.45	13		0.55	17		0.80
	25	8		0.35	9		0.42	11		0.52	14		0.63	18		0.94
	30	8		0.39	10		0.45	12		0.55	15		0.70	19		1.05
	40	9		0.42	10		0.50	12		0.60	16		0.80	19		1.30
180	20	7		0.80	9		1.00	9		1.10	13		1.30	17		1.70
	25	8		0.90	9		1.10	10		1.21	14		1.49	17		1.92
	30	8		0.98	10		1.20	10		1.35	15		1.65	19		2.15
	40	9		1.05	10		1.25	11		1.53	16		2.00	19		2.50
270	20	7		1.17	9		1.40	9		1.60	13		1.90	16		2.40
	25	8		1.24	10		1.59	10		1.74	15		2.15	16		2.82
	30	8		1.31	10		1.75	10		1.95	15		2.35	17		3.00
	40	9		1.53	10		2.05	11		2.05	16		2.70	18		3.50
360	20	7		1.86	9		2.30	9		2.40	13		2.80	16		2.90
	25	8		2.03	10		2.51	10		2.61	14		3.26	17		3.40
	30	9		2.19	10		2.65	11		2.78	15		3.60	17		3.80
	40	9		2.30	11		2.75	12		3.03	15		4.10	17		4.40

METRIC

ARC	PRESSURE (kPa BARS)		8' GREEN		10' BLUE		12' BROWN		15' BLACK		17' GRAY-KV ONLY						
			Radius (M)	Flow (L/M)	Radius (M)	Flow (L/M)	Radius (M)	Flow (L/M)	Radius (M)	Flow (L/M)	Radius (M)	Flow (L/M)					
90	138	1.38	2.1		1.2	2.7		1.5	3.0		1.7	4.0		2.1	5.2		3.0
	207	2.07	2.4		1.3	2.7		1.6	3.4		2.0	4.3		2.4	5.5		3.6
	276	2.76	2.4		1.5	3.0		1.7	3.7		2.1	4.6		2.6	5.8		4.0
	345	3.45	2.7		1.6	3.0		1.9	3.7		2.3	4.9		3.0	5.8		4.9
180	138	1.38	2.1		3.0	2.7		3.8	2.7		4.2	4.0		4.9	5.2		6.4
	207	2.07	2.4		3.4	2.7		4.2	3.0		4.6	4.3		5.6	5.2		7.3
	276	2.76	2.4		3.7	3.0		4.5	3.0		5.1	4.6		6.2	5.8		8.1
	345	3.45	2.7		4.0	3.0		4.7	3.4		5.8	4.9		7.6	5.8		9.5
270	138	1.38	2.1		4.4	2.7		5.3	2.7		6.1	4.0		7.2	4.9		9.1
	207	2.07	2.4		4.7	3.0		6.0	3.0		6.6	4.6		8.1	4.9		10.7
	276	2.76	2.4		5.0	3.0		6.6	3.0		7.4	4.6		8.9	5.2		11.4
	345	3.45	2.7		5.8	3.0		7.8	3.4		7.8	4.9		10.2	5.5		13.2
360	138	1.38	2.1		7.0	2.7		8.7	2.7		9.1	4.0		10.6	4.9		11.0
	207	2.07	2.4		7.7	3.0		9.5	3.0		9.9	4.3		12.3	5.2		12.9
	276	2.76	2.7		8.3	3.0		10.0	3.4		10.5	4.6		13.6	5.2		14.4
	345	3.45	2.7		8.7	3.4		10.4	3.7		11.5	4.6		15.5	5.2		16.7

ROTORS

SPRAYS & NOZZLES

ELECTRIC VALVES

CONTROLLERS

INDEX VALVES / RCW

CHARTS

FIXED PATTERN NOZZLE PERFORMANCE

FEMALE THREAD

8' ft.

NOZZLE	NUMBER	PRESSURE (PSI)	RADIUS (FT.)	FLOW (GPM)
	90° FN8Q	15	5'	0.18
		20	6'	0.21
		25	7'	0.24
		30	8'	0.26
	180° FN8H	15	5'	0.37
		20	6'	0.42
		25	7'	0.47
		30	8'	0.52
	270° FN8TQ	15	5'	0.55
		20	6'	0.63
		25	7'	0.71
		30	8'	0.78
	360° FN8F	15	5'	0.74
		20	6'	0.86
		25	7'	0.96
		30	8'	1.05





8' ft. Metric

NOZZLE	NUMBER	PRESSURE (kPa / BAR)	RADIUS (M)	FLOW (L/M)
	90° FN8Q	100 1.0	1.7	.68
		150 1.5	2.1	.79
		200 2.0	2.4	.91
		210 2.1	2.4	.98
	180° FN8H	100 1.0	1.7	1.4
		150 1.5	2.1	1.6
		200 2.0	2.4	1.8
		210 2.1	2.4	2.0
	270° FN8TQ	100 1.0	1.7	2.1
		150 1.5	2.1	2.4
		200 2.0	2.4	2.7
		210 2.1	2.4	3.0
	360° FN8F	100 1.0	1.7	2.8
		150 1.5	2.1	3.3
		200 2.0	2.4	3.6
		210 2.1	2.4	4.0





10' ft.

NOZZLE	NUMBER	PRESSURE (PSI)	RADIUS (FT.)	FLOW (GPM)
	90° FN10Q	15	7'	0.29
		20	8'	0.33
		25	9'	0.36
		30	10'	0.39
	180° FN10H	15	7'	0.58
		20	8'	0.65
		25	9'	0.72
		30	10'	0.79
	270° FN10TQ	15	7'	0.87
		20	8'	0.98
		25	9'	1.08
		30	10'	1.18
	360° FN10F	15	7'	1.16
		20	8'	1.30
		25	9'	1.44
		30	10'	1.58





10' ft. Metric

NOZZLE	NUMBER	PRESSURE (kPa / BAR)	RADIUS (M)	FLOW (L/M)
	90° FN10Q	100 1.0	2.1	1.1
		150 1.5	2.4	1.2
		200 2.0	3.0	1.4
		210 2.1	3.1	1.5
	180° FN10H	100 1.0	2.1	2.2
		150 1.5	2.4	2.5
		200 2.0	3.0	2.7
		210 2.1	3.1	3.0
	270° FN10TQ	100 1.0	2.1	3.3
		150 1.5	2.4	3.7
		200 2.0	3.0	4.1
		210 2.1	3.1	4.5
	360° FN10F	100 1.0	2.1	4.4
		150 1.5	2.4	4.9
		200 2.0	3.0	5.5
		210 2.1	3.1	6.0

12' ft.

NOZZLE	NUMBER	PRESSURE (PSI)	RADIUS (FT.)	FLOW (GPM)
	90° FN12Q	15	9'	0.45
		20	10'	0.53
		25	11'	0.60
		30	12'	0.65
	180° FN12H	15	9'	0.90
		20	10'	1.05
		25	11'	1.20
		30	12'	1.30
	270° FN12TQ	15	9'	1.35
		20	10'	1.58
		25	11'	1.80
		30	12'	1.95
	360° FN12F	15	9'	1.80
		20	10'	2.10
		25	11'	2.40
		30	12'	2.60

12' ft. Metric

NOZZLE	NUMBER	PRESSURE (kPa / BAR)	RADIUS (M)	FLOW (L/M)
	90° FN12Q	100 1.0	2.7	1.7
		150 1.5	3.2	2.0
		200 2.0	3.6	2.3
		210 2.1	3.7	2.5
	180° FN12H	100 1.0	2.7	3.4
		150 1.5	3.2	4.0
		200 2.0	3.6	4.5
		210 2.1	3.7	4.9
	270° FN12TQ	100 1.0	2.7	5.1
		150 1.5	3.2	6.0
		200 2.0	3.6	6.8
		210 2.1	3.7	7.4
	360° FN12F	100 1.0	2.7	6.8
		150 1.5	3.2	7.9
		200 2.0	3.6	9.1
		210 2.1	3.7	9.8

Data represents test results in zero wind. Adjust for local conditions. Radius may be reduced with nozzle retention screw.

FEMALE THREAD (CON'T)

15' ft.				
NOZZLE	NUMBER	PRESSURE (PSI)	RADIUS (FT.)	FLOW (GPM)
	FN15Q	15	11'	0.65
		20	12'	0.75
		25	14'	0.82
		30	15'	0.92
	FN15H	15	11'	1.30
		20	12'	1.50
		25	14'	1.65
		30	15'	1.85
	FN15TQ	15	11'	1.95
		20	12'	2.25
		25	14'	2.48
		30	15'	2.78
	FN15F	15	11'	2.60
		20	12'	3.00
		25	14'	3.30
		30	15'	3.70

15' ft. Metric					
NOZZLE	NUMBER	PRESSURE (kPa / BAR)	RADIUS (M)	FLOW (L/M)	
	FN15Q	100	1.0	3.4	2.5
		150	1.5	3.9	2.8
		200	2.0	4.5	3.1
		210	2.1	4.6	3.5
	FN15H	100	1.0	3.4	4.9
		150	1.5	3.9	5.7
		200	2.0	4.5	6.2
		210	2.1	4.6	7.0
	FN15TQ	100	1.0	3.4	7.4
		150	1.5	3.9	8.6
		200	2.0	4.5	9.4
		210	2.1	4.6	10.6
	FN15F	100	1.0	3.4	9.8
		150	1.5	3.9	11.4
		200	2.0	4.5	12.5
		210	2.1	4.6	14.0

MALE THREAD

12' ft.				
NOZZLE	NUMBER	PRESSURE (PSI)	RADIUS (FT.)	FLOW (GPM)
	P12Q	20	11'	0.5
		25	12'	0.7
		40	13'	0.8
		50	14'	0.9
	P12H	20	11'	0.9
		25	12'	1.1
		40	13'	1.4
		50	14'	1.5
	P12TQ	20	12'	1.2
		25	12'	1.4
		40	14'	1.7
		50	15'	2.0
	P12F	20	10'	1.6
		25	12'	1.8
		40	13'	2.1
		50	14'	2.4

12' ft. Metric					
NOZZLE	NUMBER	PRESSURE (kPa / BAR)	RADIUS (M)	FLOW (L/M)	
	P12Q	150	1.5	3.4	1.9
		200	2.0	3.7	2.6
		300	3.0	4.0	3.0
		350	3.5	4.3	3.4
	P12H	150	1.5	3.4	3.4
		200	2.0	3.7	4.2
		300	3.0	4.0	5.3
		350	3.5	4.3	5.7
	P12TQ	150	1.5	3.7	4.5
		200	2.0	3.7	5.3
		300	3.0	4.3	6.4
		350	3.5	4.6	7.6
	P12F	150	1.5	3.0	6.1
		200	2.0	3.7	6.8
		300	3.0	4.0	7.9
		350	3.5	4.3	9.1

15' ft.				
NOZZLE	NUMBER	PRESSURE (PSI)	RADIUS (FT.)	FLOW (GPM)
	P15Q	20	15'	0.7
		30	16'	0.9
		40	17'	1.1
		50	18'	1.2
	P15H	20	14'	1.4
		30	15'	1.7
		40	16'	2.0
		50	17'	2.2
	P15TQ	20	13'	2.0
		30	15'	2.5
		40	16'	2.9
		50	16'	3.2
	P15F	20	13'	2.9
		30	15'	3.6
		40	16'	4.1
		50	17'	4.6

15' ft. Metric					
NOZZLE	NUMBER	PRESSURE (kPa / BAR)	RADIUS (M)	FLOW (L/M)	
	P15Q	150	1.5	4.6	2.6
		200	2.0	4.9	3.4
		300	3.0	5.2	4.2
		350	3.5	5.5	4.5
	P15H	200	2.0	4.3	5.3
		300	3.0	4.6	6.4
		400	4.0	4.9	7.6
		500	5.0	5.2	8.3
	P15TQ	200	2.0	4.0	7.6
		300	3.0	4.6	9.5
		400	4.0	4.9	11.0
		500	5.0	4.9	12.1
	P15F	200	2.0	4.0	11.00
		300	3.0	4.6	13.6
		400	4.0	4.9	15.5
		500	5.0	5.2	17.4

SPECIAL PATTERNS

		15' ft.				15' ft. Metric					
PATTERN		MALE #	FEMALE#	PRESSURE (PSI)	RADIUS (FT.)	FLOW (GPM)		PRESSURE (kPa / BAR)	RADIUS (M)	FLOW (L/M)	
CENTER STRIP		15CS	FN15CS	20	4' x 24'	0.8		150	1.5	1.2 x 7.3	3.0
				30	4' x 30'	1.0		200	2.0	1.2 x 9.1	3.8
END STRIP		15ES	FN15ES	20	4' x 12'	0.4		150	1.5	1.2 x 7.3	1.5
				30	4' x 15'	0.5		200	2.0	1.2 x 4.6	1.9
SIDE STRIP		15SS	FN15SS	20	4' x 28'	1.1		150	1.5	1.2 x 8.5	4.2
				30	5' x 32'	1.3		200	2.0	1.5 x 9.8	4.9
HIGH LOW		15HL	FN15HL	20	H 14' x L4' x 28'	2.5		150	1.5	4.3 x 1.2 x 8.5	9.5
				30	H 15' x L5' x 32'	3.0		200	2.0	4.6 x 1.5 x 9.8	11.4

MODELS

7001	1" Female Thread or 1-1/4" Slip
7001-SL	1" Female Slip or 1-1/4" Slip
7001-BSP	1" Female BSP Thread or 1-1/4" Slip
7001-NFC	1" Female Thread or 1-1/4" Slip Without Flow Control
7001-SL-NFC	1" Female Slip or 1 1/4" Slip Without Flow Control
7001-BSP-NFC	1" Female BSP Thread or 1 1/4" Slip Without Flow Control
7001-MXB	1" Male X Barb
7001-MXB-NFC	1" Male X Barb Without Flow Control

PRO SERIES 100 VALVE

A contemporary tilt diaphragm design makes the PROSERIES 100 Valve the perfect choice for residential and commercial applications. This reliable valve offers a straight through flow pattern that dramatically reduces pressure loss and reduces the risk of trapped debris that causes other brands to fail. It has both an internal bleed and external bleed in addition to optional flow control. The inside diameter (ID) is 1 inch slip and glue or NPT/BSP. The outside diameter (OD) is 1 1/4 inch slip for added installation flexibility

SPECIFICATIONS

- Dimensions: HEIGHT: 4"
WIDTH: 3"
LENGTH: 5-1/4"
- Flow Range: .75 - 35 GPM
- Pressure Rating: 20 - 150 PSI
- Pressure Loss @ 30 GPM - 5 PSI
- Solenoid: 24 VAC 60 Cycle
- Inrush Current: .43 Amps
- Holding Current: .25 Amps



7001

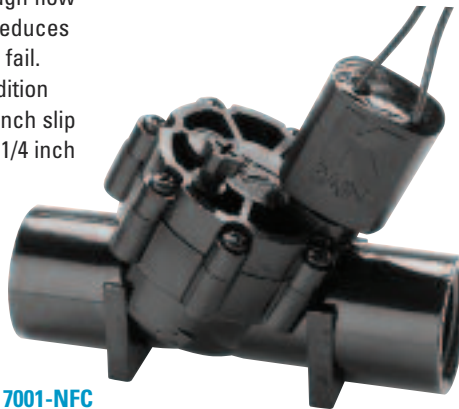

7001-NFC

PRO SERIES 100 VALVE MALE THREAD X BARB

K-Rain expands the popular ProSeries 100 Valve line with the Male X Barb 1" Valve.

The Male X Barb Valve is designed for polyethylene piping systems, requires fewer fittings and can be installed quickly.



7001-MXB

FLOW THROUGH

The unique tilted diaphragm creates a better flow path than traditional globe style electric valves by decreasing friction loss and increasing flow rate.



SELF-CLEANING SCREEN

The straight flow path allows debris to move through and the turbulent water flow cleans the diaphragm filter screen. This provides long life in applications using well or lake water.





MANUAL FLOW CONTROL

Precisely adjust flow and shut off manually. Removable handle prevents tampering.

CAPTURED PLUNGER SOLENOID

K-Rain's solenoid with captured plunger allows for easy removal when servicing without losing internal parts. Epoxy encapsulated solenoid design ensures longevity unlike the competition's overmolded solenoid.

FEATURES/BENEFITS

- Heavy Duty, Corrosion and UV Resistant PVC Construction—Increases the life of the valve.
- Combination 1" and 1 1/4"—Provides the option to increase the pipe size to the valve increasing the flow rate.
- Tilt Diaphragm/Piston Assembly—Allows for a straight flow path of the water increasing the flow rate while reducing the friction loss.
- Debris Tolerant Design—Provides flexibility for use in potable or dirty water applications.
- Manual External Bleed Screw—Provides for manual operation in system start up.
- Manual Internal Bleed Through Solenoid—Provides for manual operation without discharging water outside the valve.
- Flow Control with Removable Handle—Allows for precise flow adjustment and manual shut off and allows you to remove the handle to prevent tampering (Except 7001-NFC).
- Captured Plunger—Allows for the solenoid to be removed without losing the internal plunger.
- Self Cleaning Metering Screen—Screen is in the turbulent flow of the water allowing self cleaning action during operation.
- Five Year Limited Warranty.

K-RAIN PROSERIES 100 MODEL 7001: ELECTRIC VALVE

Construction:

The valve body is constructed of corrosion and UV resistant PVC material. Valve is available in NPT, welded slip and BSP configurations. The valve is manufactured for 3 different applications:

1. to accept 1" female slip or 1 1/4" slip installation within the same unit.
2. to accept 1" female thread or 1 1/4" slip installation within the same unit.
3. to accept 1" female BSP thread or 1 1/4" slip installation within the same unit.

Design of valve is high flow, low friction loss and includes optional flow control for precise flow adjustment and manual shut off. Valve has debris tolerant design to accommodate dirty water conditions. Valve has a manual external bleed and removable tamper-resistant flow control handle. Valve has a diaphragm piston assembly with a 50 mesh filter screen in the turbulent flow for self-cleaning purposes. Valve is controlled by a 24 VAC encapsulated solenoid, .43 amp inrush and .25 amp holding.

Operation:

Valve has a working pressure range from 20 PSI (1.38 bars) minimum to 150 PSI (10.34 bars) maximum and a recommended flow range from 5 to 30 GPM (20 to 114 LPM).



HOW TO SPECIFY

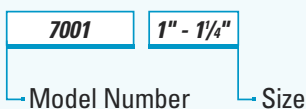

MODELS

7101	1" Female Thread, NPT
7101-SL	1" Female Slip
7101-BSP	1" Female Thread, BSP

PRO SERIES 150 VALVE 1" MODEL

K-Rain's ProSeries 150 Valves offer the irrigation professional a wide array of features and benefits.

The 1" valve has a removable metering pin and external bleed screw promoting easy maintenance and manual operation.



7101

FEATURES/BENEFITS ProSeries 150 - 1" Valve

- Heavy Duty, Corrosion and UV Resistant PVC Construction –Increases the life of the valve.
- External Bleed Screw with Removable Metering Pin–Allows for easy cleaning of the metering pin without disassembling the valve.
- Manual External Bleed Screw–Provides for manual operation in system start up.
- Manual Internal Bleed through Solenoid–Provides for manual operation without discharging water outside the valve.
- Captured Plunger–Allows for the solenoid to be removed without losing the internal plunger.
- Five Year Limited Warranty.

SPECIFICATIONS

Operating Specifications

- Pressure range: 10-150 psi
- Flow Range: .25 - 30 GPM

Dimensions:

- HEIGHT: 5 1/4"
- WIDTH: 3 1/8"
- LENGTH: 5"

Electrical Specifications

- Standard solenoid: 24 VAC 60 Cycle
- Inrush current: .4 amp
- Holding current: .2 amp

OPERATING SPECIFICATIONS

ProSeries 150 1" VALVE					
FLOW RATE - GPM	5	10	15	20	30
PSI LOSS	2.9	2.1	1.8	3.0	5.0
PRESSURE RANGE: 10-150 PSI					

HOW TO SPECIFY

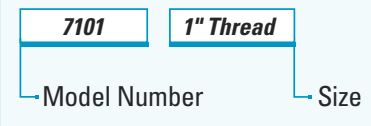

MANUAL EXTERNAL BLEED SCREW

The 1", 1 1/2" and 2" models feature a removable external bleed screw and metering pin to simplify cleaning and maintenance. With the External Bleed Screw, manual operation during start up is easy.

MODELS

7101-J	1" Female Thread Jar-Top, NPT
7101-J-SL	1" Female Slip Jar-Top
7101-J-BSP	1" Female Thread Jar-Top, BSP

PROSERIES 150 VALVE WITH JAR TOP

The Jar-Top provides the professional easy servicing access without removing the valve from the system.



7101-J



FEATURES/BENEFITS ProSeries 150 - 1" Jar-Top Valve

- Heavy Duty, Corrosion and UV Resistant PVC Construction –Increases the life of the valve.
- Threaded Jar-Top–Allows for quick removal of the cap for easy servicing after installation.
- Manual External Bleed Screw–Provides for manual operation in system start up.
- Manual Internal Bleed through Solenoid–Provides for manual operation without discharging water outside the valve.
- Captured Plunger–Allows for the solenoid to be removed without losing the internal plunger.
- Glass-Filled Nylon Screw Cap–Increased durability.
- Five Year Limited Warranty.

SPECIFICATIONS

Operating Specifications

- Pressure range: 10-150 psi
- Flow Range: .25 - 30 GPM

Dimensions:

- HEIGHT: 5 1/4"
- WIDTH: 3"
- LENGTH: 4 3/8"

Electrical Specifications

- Standard solenoid: 24 VAC 60 Cycle
- Inrush current: .4 amp
- Holding current: .2 amp

OPERATING SPECIFICATIONS

ProSeries 150 1" VALVE WITH JAR-TOP

FLOW RATE - GPM	5	10	15	20	30
PSI LOSS	3.3	3.9	2.9	3.2	6.1

PRESSURE RANGE: 10-150 PSI



NO TOOLS NEEDED

The K-Rain Jar-Top valve allows for quick and easy servicing after installation.

HOW TO SPECIFY

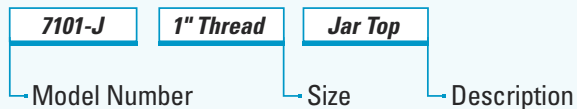

MODELS

7115	1 1/2" Female Thread, NPT
7115-BSP	1 1/2" Female Thread, BSP
7102	2" Female Thread, NPT
7102-BSP	2" Female Thread, BSP

SYSTEM FLEXIBILITY

Removable inlet cap allows for easy conversion from globe to angle-style valve.



FEATURES/BENEFITS ProSeries 150 - 1 1/2" & 2" Valves

- Heavy Duty, Corrosion and UV Resistant PVC Construction –Increases the life of the valve.
- External Bleed Screw with Removable Metering Pin– Allows for easy cleaning of the metering pin without disassembling the valve.
- Manual External Bleed Screw–Provides for manual operation in system start up.
- Manual Internal Bleed through Solenoid–Provides for manual operation without discharging water outside the valve.
- Removable Inlet Cap–Allows for easy conversion from globe to angle-style valve.
- Flow Control–Allows for precise flow adjustment and manual shut off.
- Captured Plunger–Allows for the solenoid to be removed without losing the internal plunger.
- Heavy Duty Santoprene® Diaphragm–Unique design improves durability of diaphragm.
- Five Year Limited Warranty.



PRO SERIES 150 VALVES

The 1.5" and 2" models feature a removable inlet cap to easily modify the configuration from globe to angle style. They also have a removable metering pin and external bleed screw promoting easy maintenance and manual operation.

OPERATING SPECIFICATIONS

ProSeries 150 1 1/2" VALVE

FLOW RATE - GPM		20	30	40	50	60	80
PSI LOSS	GLOBE	3.0	2.6	2.3	2.9	4.1	5.5
	ANGLE	2.7	2.2	1.9	2.2	3.0	4.4

ProSeries 150 2" VALVE

FLOW RATE - GPM		20	30	40	50	60	80	100	120
PSI LOSS	GLOBE	2.0	1.9	1.7	1.5	1.6	2.9	4.8	6.2
	ANGLE	1.9	1.9	1.7	1.5	1.5	2.1	3.2	4.6

PRESSURE RANGE: 10-150 PSI

SPECIFICATIONS

Operating Specifications

- Pressure range: 20-150 psi
- Flow Range: 5 - 120 GPM

Electrical Specifications

- Standard solenoid: 24 VAC 60 Cycle
- Inrush current: .4 amp
- Holding current: .2 amp

ProSeries 150 1 1/2" VALVE-7115

- Dimensions: HEIGHT: 8" WIDTH: 4 1/4" LENGTH: 5 1/2"

ProSeries 150 2" VALVE-7102

- Dimensions: HEIGHT: 8 7/8" WIDTH: 4 7/8" LENGTH: 6 1/3"

HOW TO SPECIFY

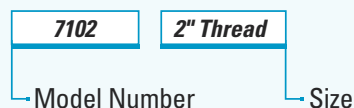

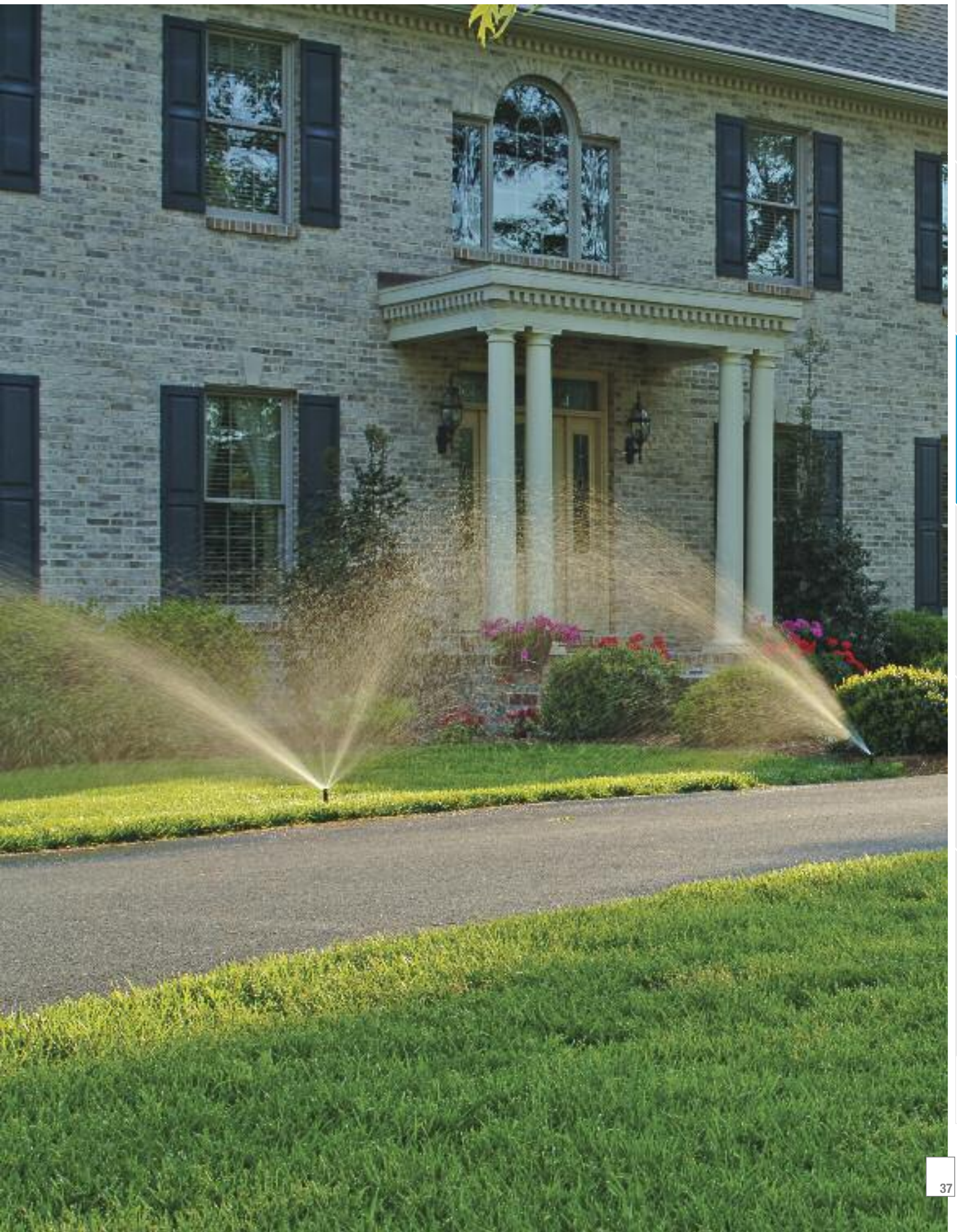

ROTORS

SPRAYS & NOZZLE

ELECTRIC VALVES

CONTROLLERS

INDEX VALVES / RCW

CHARTS

MODELS

7201	1" Female Thread
7201-J	1" Female Thread Jar-Top
7215	1 1/2" Female Thread
7202	2" Female Thread
7201-BSP	1" Female Thread, BSP
7215-BSP	1 1/2" Female Thread, BSP
7202-BSP	2" Female Thread, BSP

RPS 200

The RPS 200 Valve is a durable feature packed electric valve designed to handle irrigation applications up to 200 psi.



SPECIFICATIONS

Operating Specifications

- Pressure range: 6-200 psi

Electrical Specifications

- Standard solenoid: 24 VAC
- Inrush current: .375 amp
- Holding current: .250 amp

RPS 200 SERIES 1" VALVE-7201

- Dimensions: HEIGHT: 5 1/4" WIDTH: 3 1/8" LENGTH: 5 1/8"

RPS 200 SERIES 1" VALVE WITH JAR-TOP-7201-J

- Dimensions: HEIGHT: 5 3/4" WIDTH: 3 1/8" LENGTH: 4 3/4"

RPS 200 SERIES 1 1/2" VALVE-7215

- Dimensions: HEIGHT: 6 3/4" WIDTH: 4 1/4" LENGTH: 6 1/4"

RPS 200 SERIES 2" VALVE-7202

- Dimensions: HEIGHT: 7" WIDTH: 4 1/4" LENGTH: 7 1/4"

FEATURES/BENEFITS

- Durable glass-filled nylon construction and reinforced rubber diaphragm—ensures long life and reliable performance.
- Flow control to adjust water flow as needed (except 7201-J).
- Large internal openings and self cleaning diaphragm during every cycle—reduces maintenance time.
- Water flow indicator—ensures proper installation every time.
- Captured Plunger—Allows for the solenoid to be removed without losing the internal plunger.
- Electric or manual operation.
- Two Year Limited Warranty.

OPERATING SPECIFICATIONS

RPS 200 SERIES 1" VALVE

FLOW RATE - GPM	5	10	15	20	25	30	40
PSI LOSS	.4	1.16	2.45	4.65	7.25	9.70	15.9

RPS 200 SERIES 1" VALVE WITH JAR-TOP

FLOW RATE - GPM	5	10	15	20	25	30	40
PSI LOSS	1.45	1.90	3.00	5.80	8.75	10.70	18.00

RPS 200 SERIES 1 1/2" VALVE

FLOW RATE - GPM	20	25	30	40	50	60	80	100
PSI LOSS	2.73	3.04	2.90	2.90	3.41	4.24	7.61	12.9

RPS 200 SERIES 2" VALVE

FLOW RATE - GPM	20	25	30	40	50	60	80	100	120	150
PSI LOSS	2.90	2.54	2.17	2.17	2.75	3.40	5.50	7.83	11.66	20.0

PRESSURE RANGE: 6-200 PSI

HOW TO SPECIFY

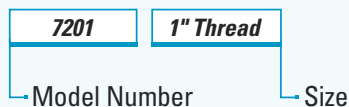

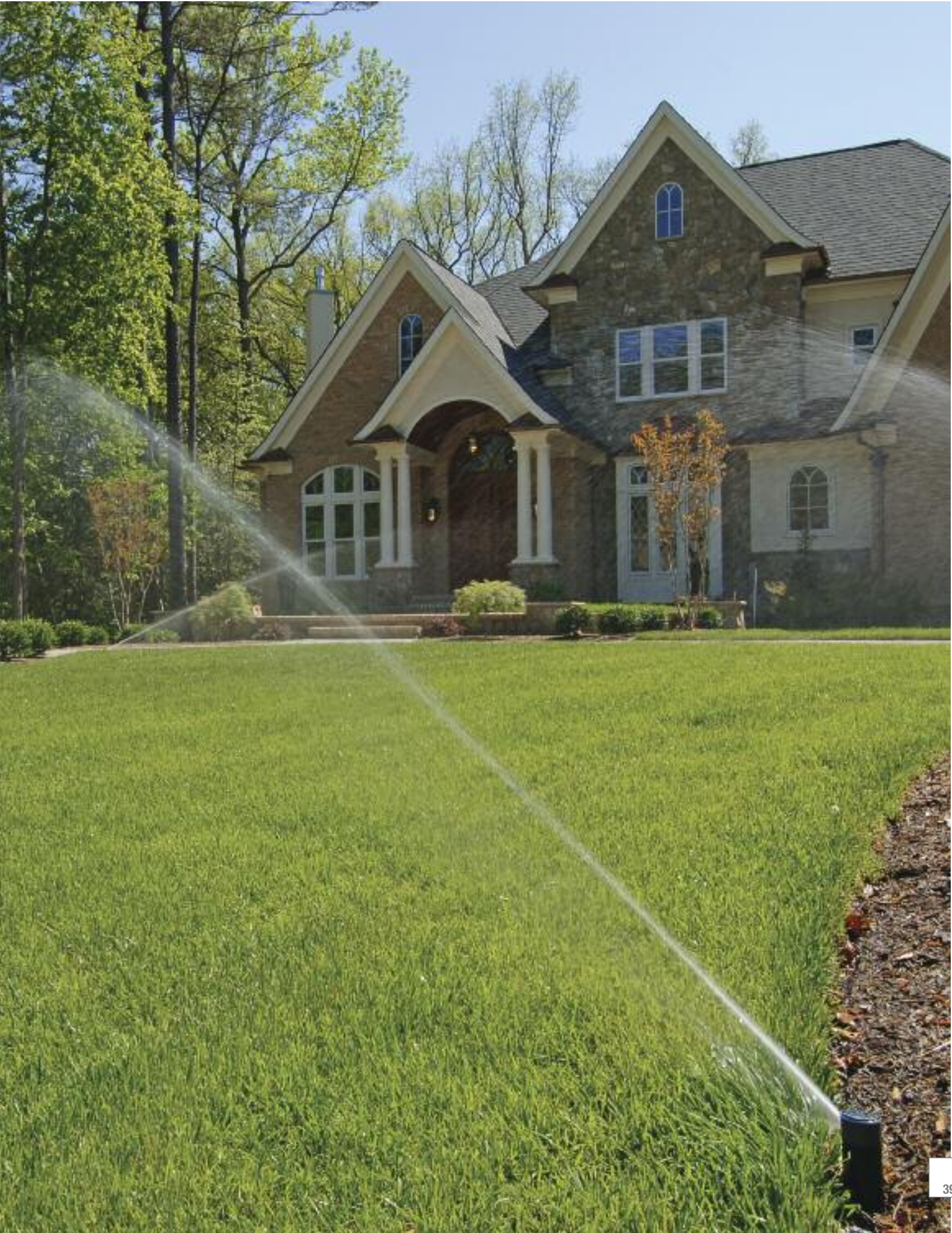

ROTORs

SPRAYS & NOZZLE

ELECTRIC VALVES

CONTROLLERS

INDEX VALVES / RCW

CHARTS

MODELS

3504	4 Station, 110 Volt External Transformer
3504-220	4 Station, 220 Volt External Transformer
3506	6 Station, 110 Volt External Transformer
3506-220	6 Station, 220 Volt External Transformer

RPS 46 MINI IRRIGATION CONTROLLER

Designed for residential applications, the RPS 46 has four individual programs to allow for efficient watering on separate programs.

A key feature of this unit is the water budgeting feature which allows easy adjustment of watering schedules as the seasons change.



FEATURES/BENEFITS

- 4 & 6 Station Models—Perfect for residential lawns.
- 4 Fully Independent Programs—Allowing up to 4 starts per program. Maximum 16 starts per day.
- Indoor Models with External Transformer and Plug.
- Seasonal Adjustment—Allows for quick adjustment of watering durations in 25% increments, from 25% to 150%.
- Rain Sensor Ready—Accepts rain sensor and is controlled by bypass switch.
- Flexible Manual Operation—Run a program, run a station or test system.
- Battery Back-Up—Saves program during power outages.
- Two Year Limited Warranty.

SPECIFICATIONS

Operating Specifications

- Dimensions: HEIGHT: 5.7"
WIDTH: 4.5"
DEPTH: 1.7"
- Station Run Times: 1 min. to 12 hours 59 min.
- Programs: 4
- Start Times: 4 per program
- Watering Schedule: 7 day calendar with individual day selection, ODD/ EVEN day or interval watering.
- Rain Sensor Ready: Inhibits automatic watering when wet conditions are detected by a suitable rain sensor.
- Master valve/Pump start terminal.
- Automatic, semi-automatic & single station manual operation.

Electrical Specifications

- Electrical Power Supply: 110-120 VAC/60Hz/230 VAC 50Hz
- Electrical Outputs: 24 Volt AC, 0.85 AMP
- To Solenoid Valve: 24 VAC 50/60 Hz 0.5 AMPS max.
- Total output load must not be exceeded by the valves and pump start requirements.
- Overload protection: Standard 20mm 1.0 AMP fuse
- Power Failure: 9 Volt standard alkaline battery maintains clock and program up to 2 weeks.
- Wiring: The output circuits should be installed and protected in accordance with wiring rules.

HOW TO SPECIFY

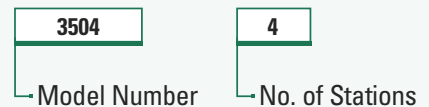

MODELS

3604	4 station, 110 Volt internal transformer
3604-220	4 station, 220 Volt internal transformer
3606	6 station, 110 Volt internal transformer
3606-220	6 station, 220 Volt internal transformer
3609	9 station, 110 Volt internal transformer
3609-220	9 station, 220 Volt internal transformer

RPS 469 MID-SIZE IRRIGATION CONTROLLER

Designed for residential & light commercial applications, the RPS 469 has six individual programs to allow for efficient watering on separate programs. This product features Rain Sensor Ready (RSR) technology which allows individual stations to be controlled by a rain sensor.



FEATURES/BENEFITS

- 4, 6 & 9 Station Models—Perfect for residential & light commercial applications.
- 6 fully Independent Programs—Allowing up to 6 starts per program. Maximum 36 starts per day.
- Indoor/Outdoor
- Water Conservative—Allows for quick adjustment of watering durations in 10% increments, from 10% to 200.
- Rain Sensor Ready—Accepts rain sensor and allows individual stations to be set and controlled by the sensor.
- Flexible Manual Operation—Automatic, semi-automatic and single station manual.
- System Test—Allows a full system check for valve operation.
- Permanent Memory—Saves programs during power outages.
- Weatherproof Enclosure—Ensures long product life.
- Two Year Limited Warranty.

SPECIFICATIONS

Operating Specifications

- Dimensions: HEIGHT: 8.8"
WIDTH: 7.9"
DEPTH: 2.9"
- Station Run Times: 1 min. to 12 hours 59 min.
- Programs: 6
- Start Times: 6 per program
- Water Schedule: 7 day calendar with individual day selection, or 1 to 15 day interval watering, or 365 day calendar for ODD/EVEN day watering.
- Rain Sensor Ready
- Inhibits automatic watering when wet conditions are detected by a suitable rain sensor.
- Master Valve/pump can be enabled or disabled by station or by program.
- Automatic, semi-automatic & single station manual operation.
- Capable of programming remotely using a standard 9 Volt alkaline battery. Permanent memory saves programs during power outages.

Electrical Specifications

- Electrical Power Supply: 110-120 VAC/60Hz/230 VAC 50Hz
- Electrical Outputs: 24 Volts AC, 1.0 AMP
- To Solenoid Valve: 24 VAC 50/60 Hz 0.75 AMPS max. **Note:** up to 3 valves per station on inbuilt model.
- Total output load must not be exceeded by the valves and pump start requirements.
- Overload Protection: Standard 20mm 1.0 AMP fuse
- Power Failure: 9 volt standard alkaline battery permanently maintains programs.
- Power Failure: The controller has permanent memory so the data is always backed up even during power outages.
- Wiring: The output circuits should be installed and protected in accordance with wiring rules.

HOW TO SPECIFY

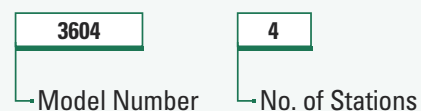

MODELS

3712	12 station, 110 Volt internal transformer
3712-220	12 station, 220 Volt internal transformer
3718	18 station, 110 Volt internal transformer
3718-220	18 station, 220 Volt internal transformer
3724	24 station, 110 Volt internal transformer
3724-220	24 station, 220 Volt internal transformer

RPS 1224 IRRIGATION CONTROLLER

With 12, 18 and 24 stations, the RPS 1224 covers all your needs regardless of the size or complexity of the project at hand.



FEATURES/BENEFITS

- 12, 18 & 24 Station Models—Perfect for residential & light commercial applications.
- 8 fully Independent Programs—Allowing up to 8 starts per program. Maximum 64 starts per day.
- Indoor/Outdoor
- Water Conservative—Allows for quick adjustment of watering durations in 10% increments, from 10% to 200.
- Rain Sensor Ready—Accepts rain sensor and allows individual stations to be set and controlled by the sensor.
- Flexible Manual Operation—Automatic, semi-automatic and single station manual.
- System Test—Allows a full system check for valve operation.
- Permanent Memory—Saves programs during power outages.
- Weatherproof Enclosure—Ensures long product life.
- Two Year Limited Warranty.

SPECIFICATIONS

Operating Specifications

- Dimensions: HEIGHT: 9 3/8"
WIDTH: 10 1/4"
DEPTH: 4 1/8"
- Station Run Times: 1 min. to 12 hours 59 min.
- Programs: 8
- Start Times: 8 per program
- Water Schedule: 7 day calendar with individual day selection, or 1 to 15 day interval watering, or 365 day calendar for ODD/EVEN day watering.
- Rain Sensor Ready
- Inhibits automatic watering when wet conditions are detected by a suitable rain sensor.
- Two Master Valve/pump connections that can be enabled or disabled by station or by program.
- Automatic, semi-automatic & single station manual operation.
- Capable of programming remotely using a standard 9 Volt alkaline battery. Permanent memory saves programs during power outages.

Electrical Specifications

- Electrical Power Supply: 110-120 VAC/60Hz/230 VAC 50Hz
- Electrical Outputs: 24 Volts AC, 1.25 AMP
- To Solenoid Valve: 24 VAC 50/60 Hz 0.75 AMPs max. **Note:** up to 3 valves per station on inbuilt model.
- Total output load must not be exceeded by the valves and pump start requirements.
- Overload Protection: Standard 20mm 1.0 AMP fuse
- Power Failure: 9 volt standard alkaline battery permanently maintains programs.
- Power Failure: The controller has permanent memory so the data is always backed up even during power outages.
- Wiring: The output circuits should be installed and protected in accordance with wiring rules.

HOW TO SPECIFY



MODELS

3200	4 station, 120/240 VAC internal transformer
3204	4 station expansion, 120/240 VAC internal transformer

PRO EX MODULAR IRRIGATION CONTROLLER

The K-Rain PRO EX Modular Irrigation Controller can be easily expanded from 4 to 16 stations. The large backlit display and user-friendly programming takes the PRO EX to a whole new level for irrigation controllers.

Features like Program Display, Valve Locate, Default Programming and Rain Sensor Ready, just to name a few, make the PRO EX today's Irrigation Professional's choice. The PRO EX controller is easily transformed to fit any system up to 16 stations by installing 4 station expansion modules.

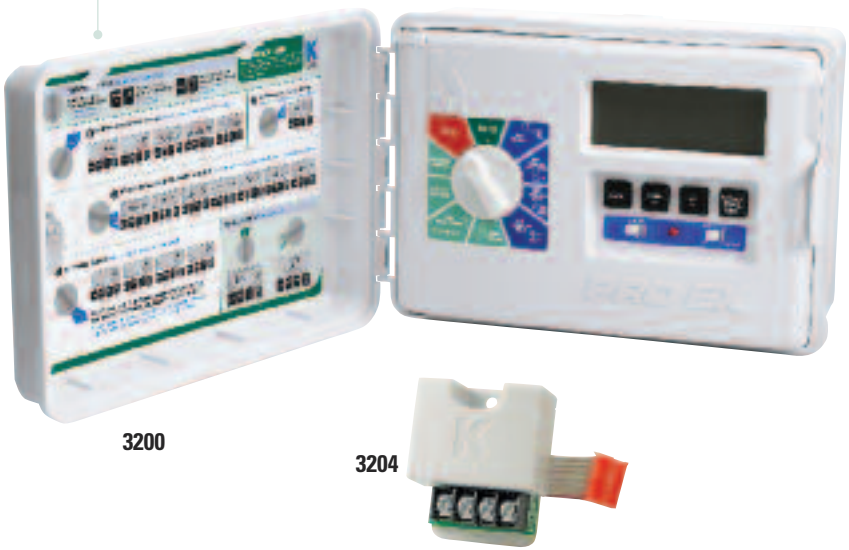

FEATURES/BENEFITS

- Hot-swappable 4 Station Modules—Allows simple controller upgrades from 4 to 16 stations while controller is in operation
- 3 Fully Independent Programs—With up to 4 separate start times per program
- Dual Voltage Transformer—Enables either 120VAC or 240VAC installations
- Large backlit LCD Screen—Permits maximum viewing for all installations
- Program Display—Full program screen display of watering days, number of start times, number of stations and special programming
- Flexible Manual Operation—Automatic, semi-automatic and single station
- System Test—Allows a full system check for valve operation
- Manual Start—Allows manual program operation at the push of a button
- Permanent Memory—Non-volatile memory saves program during power outages
- Remote Programming—Allows programming remotely by installing a standard 9V battery
- Wireless Module Connector—Allows for optional installation of wireless communication
- Diagnostic Circuit Breaker—Identifies and isolates stations with valve or wiring problems while allowing remaining program to continue
- Locate Feature—Aids in locating buried valves in field
- Station Delay/Overlap—Permits additional time between stations or dual operation for everyday hydraulic issues like well recovery, slow closing valves and water hammer
- Rain Sensor Ready—Allows programming of individual station(s) operation to be controlled by sensor
- Master Valve /Pump Start Ready—Permits programming for individual station(s) operation as needed
- Valve Test Terminal (VT)—Quick and easy matching of field wires with station during installation
- Dedicated Sensor Terminals—Enables direct sensor installation for maximum watering control
- Default Programming—Allows program to be saved and recalled without having to reprogram the controller
- Seasonal Adjust—Conserves water by allowing quick and easy global adjustment of watering times from 10-200%

SPECIFICATIONS

Operating Specifications

- Dimensions: HEIGHT: 7 1/8"
WIDTH: 11 1/2"
DEPTH: 5 1/4"
- Station Run Times: 1 second to 6 hours for all stations
- Programs: 3
- Start Times: 4 per program
- Water Schedule: Custom (day of the week), Interval (1-31 days), Odd (odd calendar days), Even (even calendar days)

Electrical Specifications

- Power Input: 120VAC ± 10% 60Hz, 230VAC ± 10% 50Hz
- Power Output: 24VAC 1.25Amp
- Power Backup: Lithium coin-cell battery maintains time and date during primary power outages while the 9V battery allows remote programming and LCD viewing
- Multi-Valve Operation: Up to 3 24VAC, 7VA solenoid valves

MODELS

2100 Single Station Controllers

2110	Voltage Input: 110 VAC, 60 Hz Output: 110 VAC, 60 Hz	Rating Single Pole, Single Throw Relay Rated for up to 1 H.P.
2112	Voltage Input: 110 VAC, 60 Hz Output: 110 VAC, 60 Hz	Rating Double Pole, Single Throw Relay Rated for up to 2 H.P.
2114	Voltage Input: 110 VAC, 60 Hz Output: 24 VAC, 30 VA	Rating Built-In Transformer
2116	Voltage Input: 110 VAC, 60 Hz Output: n/a	Rating Hydraulic 1/2 Gallon Pole, Single Throw
2120	Voltage Input: 220 VAC, 60 Hz Output: 220 VAC, 60 Hz	Rating Double Pole, Single Throw Relay Rated for up to 2 H.P.
2124	Voltage Input: 220 VAC, 60 Hz Output: 24 VAC, 20 VA	Rating Built-In Transformer

2500 Rainswitch-Ready Controllers

2510	Voltage Input: 110 VAC, 60 Hz Output: 110 VAC, 60 Hz	Rating Double Pole, Single Throw Relay Rated for up to 2 H.P.
2514	Voltage Input: 110 VAC, 60 Hz Output: 24 VAC, 30 VA	Rating Built-In Transformer
2520	Voltage Input: 220 VAC, 60 Hz Output: 220 VAC, 60 Hz	Rating Double Pole, Single Throw Relay Rated for up to 2 H.P.

2200 Short Duration Single Station Controllers

2210	Voltage Input: 110 VAC, 60 Hz Output: 110 VAC, 60 Hz	Rating Relay Rated for up to 1 H.P.
2214	Voltage Input: 110 VAC, 60 Hz Output: 24 VAC, 30 VA	Rating Built-In Transformer

K-RAIN SINGLE STATION CONTROLLERS

K-Rain's Single Station Controllers look great and stay safe with rain-tight, attractive enclosures.



FEATURES/BENEFITS

- 2100 models offer less hassle—24 hour programmable time dial with multiple start times and wide variety of timing periods including a “Skip-A-Day” 14 day program.
- UL Approved components.
- 2200 models are perfect for nursery and other mist applications—10 minute programmable dial, a wide variety of timing periods in multiples of 1.5, 3, and 6 seconds and multiple start times.
- 2500 models are prewired for easy connection of a rainswitch—Allows for manual override of rainswitch from controller face
- Convenience—2520 allows operation of 24 volt rainswitch and 2 H.P. 220 volt pump with same controller
- Two Year Limited Warranty.

HOW TO SPECIFY

2110

Model Number

PUMP START RELAY

The Pump Start Relay enclosure is constructed with a corrosion resistant, UV resistant and shockproof material. The rain-tight, secure, rustproof enclosure provides a safe and secure connection in a housing built to last.



FEATURES/BENEFITS

- Industrial, Rain Tight, Secure, Rustproof Enclosure—Industrial-grade enclosure ensures long product life and deters tampering.
- U.L. Approved components.
- Large Easy Access Enclosure—Provides easy accessibility during wiring.
- Enclosure has 8 Recessed Knock-Outs—Provides easy connections from any direction.
- 110 VAC or 24 VAC Coils Available—Provides for a variety of applications up to 10 HP.
- Plastic Inset Cover Screws—Provides extra system security, reduces liability and deters tampering.
- Two Year Limited Warranty.

K-RAIN MODEL 1500: INDUSTRIAL PUMP START RELAYS

Construction:

Pump start relay enclosure is constructed with heavy duty corrosion resistant, UV resistant and shockproof material. The enclosure has four recessed screws in the front cover constructed from the same material as the enclosure. The enclosure has no less than 8 knockouts for easy access and wiring. The enclosure has a water tight seal when closed.

Operation:

Pump start relays are U.L. rated and available to operate 2 HP up to 10 HP pumps; coils are available in 110 VAC and 24 VAC.



MODELS

1510	Coil Specifications 120 VAC, 60 Hz Inrush: 35 VA Sealed: 7.0 VA Resistance: (±10%): 250 OHMS	Double Pole, Single Throw Inductive: 20 AMP Resistive: 30 AMP Input: 120 VAC - up to 2 H.P. UL Rated
	Mini Coil 24 VAC, 50/60 Hz Inrush: 52 mA Sealed: 1.2 VA Resistance: (±10%): 155 OHMS	
1520	Coil Specifications 240 VAC, 60 Hz Inrush: 35 VA Sealed: 7.0 VA Resistance: (±10%): 1000 OHMS	Double Pole, Single Throw Inductive: 20 AMP Resistive: 30 AMP Input: 240 VAC - up to 3 H.P. UL Rated
	Mini Coil 24 VAC, 50/60 Hz Inrush: 52 mA Sealed: 1.2 VA Resistance: (±10%): 155 OHMS	
1522	Coil Specifications 24 VAC, 60 Hz Inrush: 35 VA Sealed: 7.0 VA, 3 WATTS Resistance: (±10%): 11 OHMS	Double Pole, Single Throw Inductive: 20 AMP Resistive: 30 AMP Input: 120 VAC - up to 3 H.P. 240 VAC - up to 3 H.P.
1521	Coil Specifications 110 VAC, 60 Hz Inrush: 42 VA Sealed: 8.5 VA, 3.6 WATTS Resistance: (±10%): 210 OHMS	Double Pole, Single Throw Inductive: 20 AMP Resistive: 30 AMP Input: 120 VAC - up to 3 H.P. 240 VAC - up to 3 H.P.
1552	Coil Specifications 24 VAC, 60 Hz Inrush: 60 VA Sealed: 7 VA, 2.3 WATTS Resistance: (±10%): 5.61 OHMS	Double Pole, Single Throw Inductive: 40 AMP Resistive: 50 AMP Input: 120 VAC - up to 3 H.P. 240 VAC - up to 5 H.P.
1551	Coil Specifications 110 VAC, 60 Hz Inrush: 77 VA Sealed: 10 VA, 4 WATTS Resistance: (±10%): 89.5 OHMS	Double Pole, Single Throw Inductive: 40 AMP Resistive: 50 AMP Input: 120 VAC - up to 3 H.P. 240 VAC - up to 5 H.P.
1553	Coil Specifications 24 VAC, 60 Hz Inrush: 60 VA Sealed: 7 VA, 2.7 WATTS Resistance: (±10%): 5.61 OHMS	THREE PHASE OPERATION Triple Pole, Single Throw Inductive: 40 AMP Resistive: 50 AMP Input: 120 VAC - up to 3 H.P. 240 VAC - up to 10 H.P.

SPECIFICATIONS

- Dimensions: HEIGHT: 7"
WIDTH: 5"
DEPTH: 4-5/8"

HOW TO SPECIFY

1522

Model Number

4000 SERIES INDEXING VALVE

Four Outlet, 1 1/4" x 1-1/4" Models

4400	No Cam
4402	Cammed for 2 Zone Operation
4403	Cammed for 3 Zone Operation
4404	Cammed for 4 Zone Operation

Six Outlet, 1 1/4" x 1" Models

4600	No Cam
4602	Cammed for 2 Zone Operation
4603	Cammed for 3 Zone Operation
4604	Cammed for 4 Zone Operation
4605	Cammed for 5 Zone Operation
4606	Cammed for 6 Zone Operation

OTHER OPTIONS: ADD TO PART NUMBER

RCW	Reclaimed Water Use
-----	---------------------

4000 SERIES INDEXING VALVE

The 4000 offers a reliable, economical way to automate multiple zoned residential and small commercial irrigation systems.

FOR MORE INFORMATION
ON RCW PRODUCTS, PLEASE
SEE PAGES 36 AND 37.



HOW TO SPECIFY

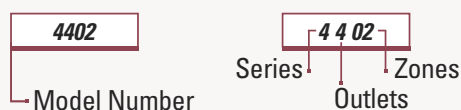

FEATURES/BENEFITS

- ABS Polymer Construction—High-strength, non-corrosive body for long product life.
- Available in 4 and 6 Outlet Models—Can quickly and easily change from two to six watering zones.
- Simplicity of Design—Valves are easily maintained and serviced for long product life.
- Operates at Low 10 GPM at Pressures of 25-75 PSI—Reliably automates multiple zoned residential and small commercial irrigation or wastewater systems.
- Two Year Limited Warranty.

K-RAIN 4000 SERIES INDEXING VALVE

These patented indexing valves allow for the number of watering zones to be changed quickly and easily. They are ideally suited for both city water and pump applications and may also be used for onsite wastewater or effluent water applications. The simplicity of design and few moving parts ensures ease of maintenance and long service life.

The 4000 valve is available in 4 or 6 outlet models. A quick change of the cam allows the valve to operate from 2 to 6 zones. The valve will operate with flows as low as 10 GPM and at pressures of 25 to 75 PSI.

SPECIFICATIONS

- Constructed of High Strength, Non-Corrosive ABS Polymer
- Flow Range:
4 Outlet Valve: 10-40 GPM
6 Outlet Valve: 10-40 GPM
- Pressure Rating: 25 - 75 PSI
- Pressure Loss:

4 Outlet Valve:	Flow (GPM)	10	20	30	40
	PSI Loss	2.0	3.0	4.5	6.4
6 Outlet Valve:	Flow (GPM)	10	20	30	
	PSI Loss	2.5	4.5	7.5	
- 4000 Series Valves are available with 1" inlet and outlet by custom order.
- Dimensions:
HEIGHT: 5-3/4"
WIDTH: 5-3/4"

MODELS

Four Outlet Models

6402	Cammed for 2 Zone Operation
6403	Cammed for 3 Zone Operation
6404	Cammed for 4 Zone Operation

Six Outlet Models

6605	Cammed for 5 Zone Operation
6606	Cammed for 6 Zone Operation

OTHER OPTIONS: ADD TO PART NUMBER

RCW	Reclaimed Water Use
------------	---------------------

SPECIFICATIONS

- Construction:
Valve Top/Housing: Die Cast Metal
Valve Outlets: High Strength ABS Polymer
- Flow Range: 15-150 GPM
- Pressure Rating: 25 - 150 PSI
- Pressure Loss:

4 Outlet Valve: Flow (GPM)	20	40	60	80	100
PSI Loss	2.5	3.5	5.0	7.5	10.0
6 Outlet Valve: Flow (GPM)	20	40	60	80	100
PSI Loss	3.0	4.0	6.0	9.0	11.0
- Inlet: Threaded 1-1/2" NPT Connection
- Outlets: Slip and Glue Connections to 1-1/2" PVC Pipe
- Dimensions: HEIGHT: 7", WIDTH: 8"

6000 INDEXING VALVE

The 6000 line of indexing valves offers exceptional reliability and durability even under the dirtiest water conditions.

FOR MORE INFORMATION ON RCW PRODUCTS, PLEASE SEE PAGES 36 AND 37.



FEATURES/BENEFITS

- Metal Die-Cast Body—Durable, long lasting, and capable of high pressure applications.
- Available in 4 and 6 Outlet Models—Can quickly and easily change from two to six watering zones.
- Simplicity of Design—Valves are easily maintained and serviced for long product life.
- Operates at 15 GPM at Pressures of 25–150 PSI- Ideal for pump-fed systems or high-flow city water systems.
- Built-in Atmospheric Vacuum Breaker—Releases any vacuum created between the pump and the valve on shut down.
- Two Year Limited Warranty.

K-RAIN MODEL 6000: INDEXING VALVE

With a metal die-cast body, the 6000 valves are capable of high pressure applications and are recommended to be used on pump fed systems or high-flow city water systems. The 6000 is also ideal for onsite wastewater and effluent water applications.

The 6000 valve is available in 4 or 6 outlet models that are cammed for 2 to 6 zone operation. With only one moving part (the stem and disc assembly), the valve is easily serviced and maintained.

The valve requires 15 GPM to operate and works at pressures from 25 to 150 PSI.



HOW TO SPECIFY

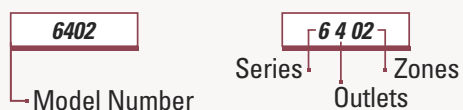

K-RAIN ROTORS AND SPRAYS FOR RECLAIMED WATER



Worldwide regulations frequently require reclaimed water usage sites to use components identified with a purple cap or collar. K-rain manufactures an entire line of rotors, sprays and indexing valves to help you adhere to these rules.

The RCW series is designed specifically for use on reclaimed water systems. Flexibility in system design, achieved through a wide selection of nozzles, guarantees matched precipitation.

RCW models are available in the ProPlus and the K-Spray models. See relative pages for detailed specifications.

MODELS

K-RAIN K-SPRAY RCW SERIES

73001-RCW	3" Pop-Up
74001-RCW	4" Pop-Up
76001-RCW	6" Pop-Up
71201-RCW	12" Pop-Up

KRAIN PROPLUS RCW

11003-RCW	ProPlus for Reclaimed Water w/Low Angle Nozzle
------------------	--

FEATURES/BENEFITS

The ProPlus RCW Rotors

- Heavy Duty Rubber Cover (purple)—Seals out dirt and increases product durability, positively identifies the use of reclaimed water reducing liability.
- Five Year Limited Warranty.

The K-Sprays

- Using a low angle nozzle ensures the correct trajectory of reclaimed water.
- Two Year Limited Warranty.

PROPLUS™ RCW

Tough, proven and advanced, the PROPLUS™ is the leader in it's class. *Set it and forget it.* Arc Memory Clutch returns the rotor to its preset position.



K-SPRAY RCW

K-Spray pop-ups are ideal for watering smaller areas, ground cover or shrub areas.

MODELS

4000-RCW Four Outlet Models

4400-RCW	No Cam
4402-RCW	Cammed for 2 Zone Operation
4403-RCW	Cammed for 3 Zone Operation
4404-RCW	Cammed for 4 Zone Operation

4000-RCW Six Outlet Models

4600-RCW	No Cam
4602-RCW	Cammed for 2 Zone Operation
4603-RCW	Cammed for 3 Zone Operation
4604-RCW	Cammed for 4 Zone Operation
4605-RCW	Cammed for 5 Zone Operation
4606-RCW	Cammed for 6 Zone Operation

6000-RCW Four Outlet Models

6402-RCW	Cammed for 2 Zone Operation
6403-RCW	Cammed for 3 Zone Operation
6404-RCW	Cammed for 4 Zone Operation

6000-RCW Six Outlet Models

6605-RCW	Cammed for 5 Zone Operation
6606-RCW	Cammed for 6 Zone Operation

FEATURES/BENEFITS

- Available in 4 and 6 Outlet Models—Can quickly and easily change from two to six watering zones.
- Simplicity of Design—Valves are easily maintained and serviced for long product life.

The 4000 RCW Indexing Valve

- ABS Polymer Construction—High-strength, non-corrosive body for long product life.
- Operates at Low 10 GPM at Pressures of 25-75 PSI—Reliably automates multiple zoned residential and small commercial wastewater systems.

The 6000 RCW Indexing Valve

- Metal Die-Cast Body—Durable, long lasting, and capable of high pressure applications.
- Operates at 15 GPM at Pressures of 25-150 PSI—Ideal for onsite pump-fed wastewater and effluent water applications.
- Built-in Atmospheric Vacuum Breaker—Releases any vacuum created between the pump and the valve on shut down.
- Two Year Limited Warranty.



6000-RCW INDEXING VALVE

The 6000 line of indexing valves offers exceptional reliability and durability even under the dirtiest water conditions.



4000-RCW INDEXING VALVE

The 4000 offers a reliable, economical way to automate multiple zoned residential and small commercial irrigation systems.

K-RAIN INDEXING VALVES FOR RECLAIMED WATER

The 4000-RCW Indexing valve offers a reliable, economical way to automate multiple zoned residential and small commercial wastewater systems. The simplicity of design and a minimum of moving parts ensures ease of maintenance and long service life.

These patented valves allow for the number of watering zones to be changed quickly and easily. They are ideally suited for pump applications, onsite wastewater or effluent water applications.

The 6000-RCW Indexing valve offers exceptional reliability and durability even under the dirtiest water conditions. With a metal die-cast body, the 6000-RCW valves are capable of high pressure applications and are recommended to be used on pump fed systems. The 6000-RCW series is ideal for onsite wastewater and effluent water applications.



CONVERSION TABLE FOR U.S. AND METRIC SYSTEMS

METRIC TO U.S.			
MULTIPLY			TO OBTAIN
Millimeters (mm)	x	.03937	= inches
Centimeters (cm)	x	.3937	= inches
Meters (m)	x	39.37	= inches
Meters (m)	x	3.281	= feet
Meters (m)	x	1.094	= yards
Kilometers (km)	x	.62137	= miles
Kilometers (km)	x	1093.62	= yards
Kilometers (km)	x	3280.87	= feet
Liters (l)	x	1.0567	= quarts (liq.)
Liters (l)	x	.2642	= gallons (U.S.)
Liters (l)	x	.455	= pounds
Temp. in (C° x 1.80)	+	32°	= temp. in F°

U.S. TO METRIC			
MULTIPLY			TO OBTAIN
Inches (in.)	x	25.4	= millimeters
Inches (in.)	x	2.54	= centimeters
Inches (in.)	x	.0254	= meters
Feet (ft.)	x	.3048	= meters
Yards (yds.)	x	.9144	= meters
Miles (mi.)	x	1.6093	= kilometers
Yards (yds.)	x	.0009143	= kilometers
Feet (ft.)	x	.0003048	= kilometers
Quarts (qts.)	x	.945	= liters
Gallons	x	3.78	= liters
Pounds	x	2.2	= liters
Temp. in F° - 32°	x	.5666	= temp. in C°

Kilograms per cubic centimeter (kg/cm²)	x	14.223	=	Pounds per square inch (P.S.I.)
Cubic Foot (cu. ft.) x 28.316			=	Liters (l.)

MISCELLANEOUS CONVERSION FACTORS

Feet head (ft. hd.) x .433	=	Pounds per square inch (P.S.I.)	Calorie x 3.968	=	British Thermal Unit (B.T.U.)
Pounds per square inch x 2.31	=	Feet head	Foot pounds per second x .7373	=	Watts
Meters x 3.28	=	Feet head	Kilowatts x 1.34	=	Horsepower
Inches of mercury x 1.133	=	Feet head	Square foot x 144	=	Square inches
U.S. gallons per minute x .1337	=	Cubic feet per minute	Square yard x 9	=	Square feet
Cubic feet per minute x 7.48	=	U.S. gallons per minute	Acre x 4.840	=	Square yards
British Imperial gallon x 1.201	=	U.S. gallons	Acre x 43,560	=	Square feet
Acre inches per hour x 453	=	G.P.M.	Square mile (section) x 640	=	Acres
Acre foot per day x 226	=	G.P.M.	Mile x 5280	=	Feet
1,000,000 gallons per day	=	694 G.P.M.	Cubic yard x 27	=	Cubic Feet
U.S. gallons x .833	=	British Imperial gallon	Circumference of circle x .3183	=	Diameter of circle
U.S. gallon x 8.336	=	Pounds	Diameter of circle x 3.1416	=	Circumference of circle
Acre foot x 325,850	=	U.S. gallons	Diameter of circle squared x .7854	=	Area of circle
Gallons per day x 1,000,000	=	694 gallons per minute	Radius of circle squared x 3.1416	=	Area of circle
U.S. gallons x 231	=	Cubic inches	Cubic Feet per second x 448.8	=	U.S. gallons per minute
Horsepower (H.P.) x 746	=	Watts	Cubic feet per second	=	Gallons per minute - 449
Horsepower x .746	=	Kilowatts	Velocity in feet per second	=	$\frac{.408 \times \text{U.S. g.p.m.}}{\text{Diam. of pipe squared}}$ or $\frac{144Q (\text{flow in G.P.M.})}{A1 (\text{Pipe ID}^2)}$

RESISTANCE METHOD

Required Information

- Actual one-way length of wire between the controllers and at the power source of the controllers and valves
- Allowable voltage loss along the wire circuit
- Accumulative current flowing through the wire section being sized in amperes

Resistance is calculated using formula:

$$R = \frac{1000 \times AVL}{2L \times I}$$

R = Maximum Allowable Resistance of wire in ohms per 1000 feet

AVL = Allowable voltage loss

L = Wire length (one way)

I = Inrush current

AVL for controller power wire sizing is calculated by subtracting the minimum operating voltage required by the controller from the minimum available voltage at the power source.

AVL for valve wire sizing is calculated by subtracting minimum solenoid operating voltage from controller output voltage. This number will vary depending on the manufacturer and in some cases with line pressure.

VALVE WIRE SIZING EXAMPLE:

Given: The distance from the controller to the valve is 1800 ft. The controller output is 24V. The valve has a minimum operating voltage of 20V and an inrush current of 370 mA (0.37Amps).

$$R = \frac{1000 \times 4}{2(1800) \times 0.37}$$

$$R = \frac{4000}{1332}$$

$$R = 3.00 \text{ ohms/1000 feet}$$

Wire resistance can not exceed 3.00 ohms per 1000 feet. Go to table #1 and select the proper wire size. Since 16 gauge wire has more resistance than 3.00 ohms per 1000 feet, choose 14 gauge wire.

Table 2 is a quick reference and is set up to provide maximum wire runs given the information at the bottom of the table.

TABLE 1

Resistance of Copper Wire

WIRE SIZE AWG No.	Resistance at 20° C (68° F) ohms per 1000 Feet
18	6.39
16	4.02
14	2.52
12	1.59
10	1.00
8	0.63
6	0.40
4	0.25

TABLE 2

Valve Wire Sizing (Maximum One-Way Distance in Feet Between Controller and Valve)

GROUND WIRE	CONTROL WIRE						
	18	16	14	12	10	8	6
18	850	1040	1210	1350	1460	1540	1590
16	1040	1340	1650	1920	2150	2330	2440
14	1210	1650	2150	2630	3080	3450	3700
12	1350	1920	2630	3390	4170	4880	5400
10	1460	2150	3080	4170	5400	6670	7690
8	1540	2330	3450	4880	6670	8700	10530
6	1590	2440	3700	5400	7690	10530	13330

Solenoid: 24VAC, Pressure: 150 PSI, Voltage Drop: 4V, Min. Operating Voltage: 20V, Amperage Peak: .37A

FORMULAS

PRECIPITATION RATES	(U.S.)	(METRIC)
Equilateral Triangular Spacing	P.R.= (in/hr) $\frac{(GPM \text{ of } 360) \times 96.25}{(\text{Head Spacing})^2 \times .866}$	P.R.= (mm/hr) $\frac{m3/hr \text{ of } 360 \times 1000}{m^2 \times .866}$
Square/Rectangular Spacing	P.R.= (in/hr) $\frac{(GPM \text{ of } 360) \times 96.25}{\text{head Spacing} \times \text{Row Spacing}}$	P.R.= (mm/hr) $\frac{m3/hr \text{ of } 360 \times 1000}{\text{Degrees of Arc} \times \text{Head Spacing}}$
Square/Rectangular Spacing for Specific Arc	P.R.= (in/hr) $\frac{3460 \times GPM \text{ (for any arc)}}{\text{Degrees of Arc} \times \text{Head Spacing} \times \text{Row Spacing}}$	P.R.= (mm/hr) $\frac{m3/hr \text{ (for any arc)} \times 1000}{\text{Degrees of Arc} \times \text{Head Spacing} \times \text{Row Spacing}}$
Horsepower	H.P. = $\frac{GPM \times \text{Ft of Head}}{3,960 \times \text{Pump Efficiency (expressed as a decimal)}}$	
Station Run Time	S.R.T. = (min/wk) $\frac{\text{Total Weekly Req'd (inch/wk)} \times 60 \text{ (min/hr)}}{\text{Precipitation Rate (in/hr)}}$	S.R.T.= (min/wk) $\frac{\text{Total Weekly Req'd (mm/wk)} \times 60 \text{ (min/hr)}}{\text{Precipitation Rate (mm/hr)}}$
Pipe Velocity	V= (ft/sec) $\frac{0.4085 \times \text{Flow (GPM)}}{(\text{Inside Pipe Diameter in Inches})^2}$	V= (m/sec) $\frac{1273.24 \times \text{Flow (l/sec)}}{(\text{Inside Pipe Diameter in Millimeters})^2}$
Scheduling Coefficient	S.C.= $\frac{\text{Average Precipitation Rate (in/hr)}}{\text{Lowest Precipitation Rate (in/hr)}}$	S.C.= $\frac{\text{Average Precipitation Rate (mm/hr)}}{\text{Lowest Precipitation Rate (mm/hr)}}$
Slope	S= $\frac{\text{Rise (Measure of Length)}}{\text{Run (Measure of Length)}}$	

PVC SCHEDULE 40 IPS PLASTIC PIPE

Sizes 1/2" thru 6"
Flow GPM 1 thru 600

(1120, 1220) C = 150
PSI loss per 100 feet of tube (PSI/100 FT)

SIZE	1/2"		3/4"		1"		1 1/4"		1 1/2"		2"		2 1/2"		3"		4"		6"	
OD	0.840		1.050		1.315		1.660		1.900		2.375		2.875		3.500		4.500		6.625	
ID	0.622		0.824		1.049		1.380		1.610		2.067		2.469		3.068		4.026		6.065	
WALL THK.	0.109		0.113		0.133		0.140		0.145		0.154		0.203		0.216		0.237		0.280	
FLOW G. P. M.	Velocity FPS	psi Loss	Velocity FPS	psi Loss	Velocity FPS	psi Loss	Velocity FPS	psi Loss	Velocity FPS	psi Loss	Velocity FPS	psi Loss	Velocity FPS	psi Loss	Velocity FPS	psi Loss	Velocity FPS	psi Loss	Velocity FPS	psi Loss
1	1.05	0.43	0.60	0.11	0.37	0.03	0.21	0.01	0.15	0.00										
2	2.11	1.55	1.20	0.39	0.74	0.12	0.42	0.03	0.31	0.02	0.19	0.00								
3	3.16	3.28	1.80	0.84	1.11	0.26	0.64	0.07	0.47	0.03	0.28	0.01	0.20	0.00						
4	4.22	5.60	2.40	1.42	1.48	0.44	0.85	0.12	0.62	0.05	0.38	0.02	0.26	0.01						
5	5.27	8.46	3.00	2.15	1.85	0.66	1.07	0.18	0.78	0.08	0.47	0.02	0.33	0.01	0.21	0.00				
6	6.33	11.86	3.60	3.02	2.22	0.93	1.28	0.25	0.94	0.12	0.57	0.03	0.40	0.01	0.26	0.01				
7	7.38	15.77	4.20	4.01	2.59	1.24	1.49	0.33	1.10	0.15	0.66	0.05	0.46	0.02	0.30	0.01				
8	8.44	20.20	4.80	5.14	2.96	1.59	1.71	0.42	1.25	0.20	0.76	0.06	0.53	0.02	0.34	0.01				
9	9.49	25.12	5.40	6.39	3.33	1.97	1.92	0.52	1.41	0.25	0.85	0.07	0.60	0.03	0.39	0.01				
10	10.55	30.54	6.00	7.77	3.70	2.40	2.14	0.63	1.57	0.30	0.95	0.09	0.66	0.04	0.43	0.01				
11	11.60	36.43	6.60	9.27	4.07	2.86	2.35	0.75	1.73	0.36	1.05	0.11	0.73	0.04	0.47	0.02				
12	12.65	42.80	7.21	10.89	4.44	3.36	2.57	0.89	1.88	0.42	1.14	0.12	0.80	0.05	0.52	0.02	0.30	0.00		
14	14.76	56.94	8.41	14.48	5.19	4.47	2.99	1.18	2.20	0.56	1.33	0.17	0.93	0.07	0.60	0.02	0.35	0.01		
16	16.87	72.92	9.61	18.55	5.93	5.73	3.42	1.51	2.51	0.71	1.52	0.21	1.07	0.09	0.69	0.03	0.40	0.01		
18	18.98	90.69	10.81	23.07	6.67	7.13	3.85	1.88	2.83	0.89	1.71	0.26	1.20	0.11	0.78	0.04	0.45	0.01		
20	21.09	110.23	12.01	28.04	7.41	8.66	4.28	2.28	3.14	1.08	1.90	0.32	1.33	0.13	0.86	0.05	0.50	0.01		
22			13.21	33.45	8.15	10.33	4.71	2.72	3.46	1.29	2.10	0.38	1.47	0.16	0.95	0.06	0.55	0.01		
24			14.42	39.30	8.89	12.14	5.14	3.20	3.77	1.51	2.29	0.45	1.60	0.19	1.04	0.07	0.60	0.02		
26			15.62	45.58	9.64	14.08	5.57	3.17	4.09	1.75	2.48	0.52	1.74	0.22	1.12	0.08	0.65	0.02		
28			16.82	52.28	10.38	16.15	5.99	4.25	4.40	2.01	2.67	0.60	1.87	0.25	1.21	0.09	0.70	0.02		
30			18.02	59.41	11.12	18.35	6.42	4.83	4.72	2.28	2.86	0.68	2.00	0.29	1.30	0.10	0.75	0.03		
35					12.97	24.42	7.49	6.43	5.50	3.04	3.34	0.90	2.34	0.38	1.51	0.13	0.88	0.04	0.38	0.00
40					14.83	31.27	8.56	8.23	6.29	3.89	3.81	1.15	2.67	0.49	1.73	0.17	1.00	0.04	0.44	0.01
45					16.68	38.89	9.64	10.24	7.08	4.84	4.29	1.43	3.01	0.60	1.95	0.21	1.13	0.06	0.49	0.01
50					18.53	47.27	10.71	12.45	7.87	5.88	4.77	1.74	3.34	0.73	2.16	0.26	1.25	0.07	1.55	0.01
55							11.78	14.85	8.65	7.01	5.25	2.08	3.68	0.88	2.38	0.30	1.38	0.08	0.61	0.01
60							12.85	17.45	9.44	8.24	5.72	2.44	4.01	1.03	2.60	0.36	1.51	0.10	0.66	0.01
65							13.92	20.23	10.23	9.56	6.20	2.83	4.35	1.19	2.81	0.41	1.63	0.11	0.72	0.02
70							14.99	23.21	11.01	10.96	6.68	3.25	4.68	1.37	3.03	0.48	1.76	0.13	0.77	0.02
75							16.06	26.37	11.80	12.46	7.16	3.69	5.01	1.56	3.25	0.54	1.88	0.14	0.83	0.02
80							17.13	29.72	12.59	14.04	7.63	4.16	5.35	1.75	3.46	0.61	2.01	0.16	0.88	0.02
85							18.21	33.26	13.37	15.71	8.11	4.66	5.68	1.96	3.68	0.68	2.13	0.18	0.94	0.02
90							19.28	36.97	14.16	17.46	8.59	5.18	6.02	2.18	3.90	0.76	2.26	0.20	0.99	0.03
95									14.95	19.30	9.07	5.72	6.35	2.41	4.11	0.84	2.39	0.22	1.05	0.03
100									15.74	21.22	9.54	6.29	6.69	2.65	4.33	0.92	2.51	0.25	1.10	0.03
110									17.31	25.32	10.50	7.51	7.36	3.16	4.76	1.10	2.76	0.29	1.22	0.04
120									18.88	29.75	11.45	8.82	8.03	3.72	5.20	1.29	3.02	0.34	1.33	0.05
130											12.41	10.23	8.70	4.31	5.63	1.50	3.27	0.40	1.44	0.05
140											13.36	11.74	9.37	4.94	6.06	1.72	3.52	0.46	1.55	0.06
150											14.32	13.33	10.03	5.62	6.50	1.95	3.77	0.52	1.66	0.07
160											15.27	15.03	10.70	6.33	6.93	2.20	4.02	0.59	1.77	0.08
170											16.23	16.81	11.37	7.08	7.36	2.46	4.27	0.66	1.88	0.09
180											17.18	18.69	12.04	7.87	7.80	2.74	4.53	0.73	1.99	0.10
190											18.14	20.66	12.71	8.70	8.23	3.02	4.78	0.81	2.10	0.11
200											19.09	22.72	13.38	9.57	8.66	3.33	5.03	0.89	2.21	0.12
225													15.05	11.90	9.75	4.14	5.66	1.10	2.49	0.15
250													16.73	14.47	10.83	5.03	6.29	1.34	2.77	0.18
275													18.40	17.26	11.92	6.00	6.92	1.60	3.05	0.22
300															13.00	7.05	7.55	1.88	3.32	0.26
325															14.08	8.17	8.18	2.18	3.60	0.30
350															15.17	9.38	8.81	2.50	3.88	0.34
375															16.25	10.65	9.43	2.84	4.15	0.39
400															17.33	12.01	10.06	3.20	4.43	0.44
425															18.42	13.43	10.69	3.58	4.71	0.49
450															19.50	14.93	11.32	3.98	4.99	0.54
475																	11.95	4.40	5.26	0.60
500																	12.58	4.84	5.54	0.66
550																	13.84	5.77	6.10	0.79
600																	15.10	6.78	6.65	0.92

Note: Shaded areas of the chart indicate velocities over 5 feet per second (FPS). Use with caution.

PVC SCHEDULE 80 IPS PLASTIC PIPE

Sizes 1/2" thru 6"
Flow GPM 1 thru 600

(1120, 1220) C = 150
PSI loss per 100 feet of tube (PSI/100 FT)

SIZE	1/2"		3/4"		1"		1 1/4"		1 1/2"		2"		2 1/2"		3"		4"		6"			
OD	0.840		1.050		1.315		1.660		1.900		2.375		2.875		3.500		4.500		6.625			
ID	0.546		0.742		0.957		1.278		1.500		1.939		2.323		2.900		3.826		5.761			
WALL THK.	0.147		0.154		0.179		0.191		0.200		0.218		0.276		0.300		0.337		0.432			
FLOW G. P. M.	Velocity FPS	psi Loss	Velocity FPS	psi Loss	Velocity FPS	psi Loss	Velocity FPS	psi Loss	Velocity FPS	psi Loss	Velocity FPS	psi Loss	Velocity FPS	psi Loss	Velocity FPS	psi Loss	Velocity FPS	psi Loss	Velocity FPS	psi Loss		
1	1.36	0.81	0.74	0.18	0.44	0.05	0.24	0.01	0.18	0.01	0.10	0.00										
2	2.73	2.92	1.48	0.66	0.89	0.19	0.49	0.05	0.36	0.02	0.21	0.01	0.15	0.00								
3	4.10	6.19	2.22	1.39	1.33	0.40	0.74	0.10	0.54	0.05	0.32	0.01	0.22	0.01								
4	5.47	10.54	2.96	2.37	1.78	0.69	0.99	0.17	0.72	0.08	0.43	0.02	0.30	0.01								
5	6.84	15.93	3.70	3.58	2.22	1.04	1.24	0.25	0.90	0.12	0.54	0.03	0.37	0.01	0.24	0.00						
6	8.21	22.33	4.44	5.02	2.67	1.46	1.49	0.36	1.08	0.16	0.65	0.05	0.45	0.02	0.29	0.01						
7	9.58	29.71	5.18	6.68	3.11	1.94	1.74	0.47	1.26	0.22	0.75	0.06	0.52	0.03	0.33	0.01						
8	10.94	38.05	5.92	8.56	3.56	2.48	1.99	0.61	1.45	0.28	0.86	0.08	0.60	0.03	0.38	0.01						
9	12.31	47.33	6.66	10.64	4.00	3.09	2.24	0.76	1.63	0.35	0.97	0.10	0.68	0.04	0.43	0.01						
10	13.68	57.52	7.41	12.93	4.45	3.75	2.49	0.92	1.81	0.42	1.08	0.12	0.75	0.05	0.48	0.02	0.27	0.00				
11	15.05	68.63	8.15	15.43	4.90	4.47	2.74	1.10	1.99	0.50	1.19	0.14	0.83	0.06	0.53	0.02	0.30	0.01				
12	16.42	80.63	8.89	18.13	5.34	5.26	2.99	1.29	2.17	0.59	1.30	0.17	0.90	0.07	0.58	0.02	0.33	0.01				
14			10.37	24.12	6.23	6.99	3.49	1.71	2.53	0.79	1.51	0.23	1.05	0.09	0.67	0.03	0.39	0.01				
16			11.85	30.88	7.12	8.95	3.99	2.19	2.90	1.01	1.73	0.29	1.20	0.12	0.77	0.04	0.44	0.01				
18			13.33	38.41	8.01	11.14	4.49	2.73	3.26	1.26	1.95	0.36	1.36	0.15	0.87	0.05	0.50	0.01				
20			14.82	46.69	8.90	13.54	4.99	3.31	3.62	1.52	2.17	0.44	1.51	0.18	0.97	0.06	0.55	0.02				
22			16.30	55.70	9.80	16.15	5.49	3.95	3.98	1.81	2.38	0.52	1.66	0.22	1.06	0.07	0.61	0.02				
24			17.78	65.44	10.69	18.97	5.99	4.64	4.35	2.13	2.60	0.61	1.81	0.25	1.16	0.09	0.66	0.02				
26			19.26	75.90	11.58	22.01	6.49	5.39	4.71	2.47	2.82	0.71	1.96	0.29	1.26	0.10	0.72	0.03				
28					12.47	25.24	6.99	6.18	5.07	2.83	3.03	0.81	2.11	0.34	1.35	0.11	0.78	0.03				
30					13.36	28.69	7.49	7.02	5.43	3.22	3.25	0.92	2.26	0.38	1.45	0.13	0.83	0.03	0.36	0.00		
35					15.59	38.16	8.74	9.34	6.34	4.29	3.79	1.23	2.64	0.51	1.69	0.17	0.97	0.05	0.43	0.01		
40					17.81	48.87	9.99	11.96	7.25	5.49	4.34	1.57	3.02	0.65	1.94	0.22	1.11	0.06	0.49	0.01		
45							11.24	14.88	8.16	6.83	4.88	1.96	3.40	0.81	2.18	0.28	1.25	0.07	0.55	0.01		
50							12.49	18.09	9.06	8.30	5.42	2.38	3.78	0.99	2.42	0.34	1.39	0.09	0.61	0.01		
55							13.73	21.58	9.97	9.90	5.96	2.84	4.15	1.18	2.66	0.40	1.53	0.10	0.67	0.01		
60							14.98	25.35	10.87	11.63	6.51	3.33	4.53	1.38	2.91	0.47	1.67	0.12	0.73	0.02		
65							16.23	29.40	11.78	13.49	7.05	3.87	4.91	1.61	3.15	0.55	1.81	0.14	0.79	0.02		
70							17.48	33.72	12.69	15.47	7.59	4.44	5.29	1.84	3.39	0.63	1.95	0.16	0.86	0.02		
75							18.73	38.32	13.59	17.58	8.13	5.04	5.67	2.09	3.63	0.71	2.09	0.18	0.92	0.03		
80							19.98	43.19	14.50	19.81	8.68	5.68	6.04	2.36	3.88	0.80	2.22	0.21	0.98	0.03		
85									15.41	22.16	9.22	6.36	6.42	2.63	4.12	0.90	2.36	0.23	1.04	0.03		
90									16.32	24.64	9.76	7.07	6.80	2.93	4.36	1.00	2.50	0.26	1.10	0.04		
95									17.22	27.23	10.30	7.81	7.18	3.24	4.60	1.10	2.64	0.29	1.16	0.04		
100									18.13	29.95	10.85	8.59	7.56	3.57	4.85	1.21	2.78	0.31	1.22	0.04		
110									19.94	35.73	11.93	10.25	8.31	4.25	5.33	1.45	3.06	0.38	1.35	0.05		
120													13.02	12.04	9.07	5.00	5.82	1.70	3.34	0.44	1.47	0.06
130													14.10	13.96	9.82	5.60	6.30	1.97	3.62	0.51	1.59	0.07
140													15.19	16.02	10.58	6.65	6.79	2.27	3.90	0.59	1.72	0.08
150													16.27	18.20	11.34	7.56	7.27	2.57	4.18	0.67	1.84	0.09
160													17.36	20.51	12.09	8.51	7.76	2.89	4.45	0.75	1.96	0.10
170													18.44	22.95	12.85	9.53	8.24	3.24	4.73	0.84	2.08	0.11
180													19.53	25.51	13.60	10.59	8.73	3.60	5.01	0.93	2.21	0.13
190															14.36	11.71	9.21	3.98	5.29	1.03	2.33	0.14
200															15.12	12.87	9.70	4.37	5.57	1.14	2.45	0.16
225															17.01	16.01	10.91	5.44	6.27	1.41	2.76	0.19
250															18.90	19.46	12.12	6.61	6.96	1.72	3.07	0.23
275																	13.34	7.89	7.66	2.05	3.38	0.28
300																	14.55	9.27	8.36	2.41	3.68	0.33
325																	15.76	10.75	9.05	2.79	3.99	0.38
350																	16.97	12.33	9.75	3.20	4.30	0.44
375																	18.19	14.01	10.45	3.64	4.60	0.50
400																	19.40	15.79	11.14	4.10	4.91	0.56
425																			11.84	4.59	5.22	0.63
450																			12.54	5.10	5.53	0.70
475																			13.23	5.64	5.83	0.77
500																			13.93	6.20	6.14	0.85
550																			15.32	7.40	6.76	1.01
600																			16.72	8.69	7.37	1.19

ROTORS

SPRAY HEADS

ELECTRIC VALVES

CONTROLLERS

INDEX VALVES / RCW

CHARTS

Note: ■ Shaded areas of the chart indicate velocities over 5 feet per second (FPS). Use with caution.

Velocity of flow rate values are computed from the general equation $V = .408 Q/d^2$

Friction pressure loss values are computed from the equation $[hf = 0.2083 (100/C) 1.852 Q^{1.852}/d^{4.868}] \times .433$ for psi loss per 100' of pipe.

PVC CLASS 125 IPS PLASTIC PIPE

Sizes 1" thru 6"

Flow GPM 1 thru 600

(1120, 1220) SDR 32.5 C = 150

PSI loss per 100 feet of tube (PSI/100 FT)

SIZE	1"		1 1/4"		1 1/2"		2"		2 1/2"		3"		4"		6"	
OD	1.315		1.660		1.900		2.375		2.875		3.500		4.500		6.625	
ID	1.211		1.548		1.784		2.229		2.699		3.284		4.224		6.217	
WALL THK.	0.052		0.056		0.058		0.073		0.088		0.108		0.138		0.204	
FLOW G. P. M.	Velocity FPS	psi Loss	Velocity FPS	psi Loss	Velocity FPS	psi Loss	Velocity FPS	psi Loss	Velocity FPS	psi Loss	Velocity FPS	psi Loss	Velocity FPS	psi Loss	Velocity FPS	psi Loss
1	0.27	0.02	0.17	0.01	0.12	0.00										
2	0.55	0.06	0.34	0.02	0.25	0.01	0.16	0.00								
3	0.83	0.13	0.51	0.04	0.38	0.02	0.24	0.01								
4	1.11	0.22	0.68	0.07	0.51	0.03	0.32	0.01	0.22	0.00						
5	1.39	0.33	0.85	0.10	0.64	0.05	0.41	0.02	0.28	0.01						
6	1.66	0.46	1.02	0.14	0.76	0.07	0.49	0.02	0.33	0.01						
7	1.94	0.62	1.19	0.19	0.89	0.09	0.57	0.03	0.39	0.01	0.26	0.00				
8	2.22	0.79	1.36	0.24	1.02	0.12	0.65	0.04	0.44	0.02	0.30	0.01				
9	2.50	0.98	1.53	0.30	1.15	0.15	0.73	0.05	0.50	0.02	0.34	0.01				
10	2.78	1.19	1.70	0.36	1.28	0.18	0.82	0.06	0.56	0.02	0.37	0.01				
11	3.06	1.42	1.87	0.43	1.41	0.22	0.90	0.07	0.61	0.03	0.41	0.01				
12	3.33	1.67	2.04	0.51	1.53	0.25	0.98	0.09	0.67	0.03	0.45	0.01	0.27	0.00		
14	3.89	2.22	2.38	0.67	1.79	0.34	1.14	0.11	0.78	0.05	0.52	0.02	0.32	0.01		
16	4.45	2.85	2.72	0.86	2.05	0.43	1.31	0.15	0.89	0.06	0.60	0.02	0.36	0.01		
18	5.00	3.54	3.06	1.07	2.30	0.54	1.47	0.18	1.00	0.07	0.68	0.03	0.41	0.01		
20	5.56	4.31	3.40	1.30	2.56	0.65	1.64	0.22	1.12	0.09	0.75	0.03	0.45	0.01		
22	6.12	5.14	3.74	1.56	2.82	0.78	1.80	0.26	1.23	0.10	0.83	0.04	0.50	0.01		
24	6.67	6.04	4.08	1.83	3.07	0.92	1.97	0.31	1.34	0.12	0.90	0.05	0.54	0.01		
26	7.23	7.00	4.42	2.12	3.33	1.06	2.13	0.36	1.45	0.14	0.98	0.05	0.59	0.02		
28	7.78	8.03	4.76	2.43	3.58	1.22	2.29	0.41	1.56	0.16	1.05	0.06	0.644	0.02		
30	8.34	9.13	5.10	2.76	3.84	1.39	2.46	0.47	1.68	0.18	1.13	0.07	0.68	0.02		
35	9.73	12.14	5.95	3.68	4.48	1.84	2.87	0.62	1.96	0.25	1.32	0.09	0.80	0.03	0.36	0.00
40	11.12	15.55	6.81	4.71	5.12	2.36	3.28	0.80	2.24	0.31	1.51	0.12	0.91	0.04	0.42	0.01
45	12.51	19.34	7.66	5.86	5.76	2.94	3.69	0.99	2.52	0.39	1.70	0.15	1.02	0.04	0.47	0.01
50	13.91	23.50	8.51	7.12	6.40	3.57	4.10	1.21	2.80	0.48	1.89	0.18	1.14	0.05	0.52	0.01
55	15.30	28.04	9.36	8.49	7.05	4.26	4.51	1.44	3.08	0.57	2.08	0.22	1.25	0.06	0.58	0.01
60	16.69	32.94	10.21	9.98	7.69	5.00	4.92	1.69	3.36	0.67	2.26	0.26	1.37	0.085	0.63	0.01
65	18.08	38.21	11.06	11.57	8.33	5.80	5.33	1.96	3.64	0.77	2.45	0.30	1.48	0.09	0.68	0.01
70	19.47	43.83	11.91	13.27	8.97	6.65	5.74	2.25	3.92	0.89	2.64	0.34	1.60	0.10	0.73	0.02
75			12.76	15.08	9.61	7.56	6.15	2.56	4.20	1.01	2.83	0.39	1.71	0.11	0.79	0.02
80			13.62	17.00	10.25	8.52	6.56	2.88	4.48	1.14	3.02	0.44	1.82	0.13	0.84	0.02
85			14.47	19.02	10.89	9.53	6.98	3.23	4.76	1.27	3.21	0.49	1.94	0.14	0.89	0.02
90			15.32	21.14	11.53	10.60	7.39	3.59	5.04	1.41	3.40	0.54	2.05	0.16	0.95	0.02
95			16.17	23.37	12.17	11.71	7.80	3.96	5.32	1.56	3.59	0.60	2.17	0.18	1.00	0.03
100			17.02	25.69	12.81	12.88	8.21	4.36	5.60	1.72	3.78	0.66	2.28	0.19	1.05	0.03
110			18.72	3.65	14.10	15.37	9.03	5.20	6.16	2.05	4.16	0.79	2.51	0.23	1.16	0.04
120					15.38	18.06	9.85	6.11	6.72	2.41	4.53	0.93	2.74	0.27	1.26	0.04
130					16.66	20.94	10.67	7.09	7.28	2.79	4.91	1.08	2.97	0.32	1.37	0.05
140					17.94	24.02	11.49	8.13	7.84	3.20	5.29	1.23	3.20	0.36	1.47	0.06
150					19.22	27.30	12.31	9.24	8.40	3.64	5.67	1.40	3.43	0.41	1.58	0.06
160							13.13	10.41	8.96	4.10	6.05	1.58	3.65	0.46	1.68	0.07
170							13.96	11.65	9.52	4.59	6.43	1.77	3.88	0.52	1.79	0.08
180							14.78	12.95	10.08	5.10	6.80	1.96	4.11	0.58	1.90	0.09
190							15.60	14.31	10.64	5.64	7.18	2.17	4.34	0.64	2.00	0.10
200							16.42	15.74	11.20	6.20	7.56	2.39	4.57	0.70	2.11	0.11
225							18.47	19.57	12.60	7.72	8.51	2.97	5.14	0.87	2.37	0.13
250									14.00	9.38	9.45	3.61	5.71	1.06	2.63	0.16
275									15.40	11.19	10.40	4.31	6.28	1.27	2.90	0.19
300									16.80	13.15	11.34	5.06	6.86	1.49	3.16	0.23
325									18.20	15.25	12.29	5.87	7.43	1.72	3.43	0.26
350									19.60	17.49	13.24	6.73	8.00	1.98	3.69	0.30
375											14.18	7.65	8.57	2.25	3.95	0.34
400											15.13	8.62	9.14	2.53	4.22	0.39
425											16.07	9.65	9.71	2.83	4.48	0.43
450											17.02	10.72	10.29	3.15	4.75	0.48
475											17.96	11.85	10.86	3.48	5.01	0.53
500											18.91	13.03	11.43	3.83	5.27	0.58
550													12.57	4.57	5.80	0.70
600													13.72	5.37	6.33	0.82

Note: Shaded areas of the chart indicate velocities over 5 feet per second (FPS). Use with caution.

PVC CLASS 160 IPS PLASTIC PIPE

Sizes 1" thru 6"

Flow GPM 1 thru 600

(1120, 1220) SDR 26 C = 150

PSI loss per 100 feet of tube (PSI/100 FT)

SIZE	1"		1 1/4"		1 1/2"		2"		2 1/2"		3"		4"		6"	
OD	1.315		1.660		1.900		2.375		2.875		3.500		4.500		6.625	
ID	1.195		1.532		1.754		2.193		2.655		3.230		4.154		6.115	
WALL THK.	0.060		0.064		0.073		0.091		0.110		0.135		0.173		0.225	
FLOW G. P. M.	Velocity FPS	psi Loss	Velocity FPS	psi Loss	Velocity FPS	psi Loss	Velocity FPS	psi Loss	Velocity FPS	psi Loss	Velocity FPS	psi Loss	Velocity FPS	psi Loss	Velocity FPS	psi Loss
1	0.28	0.02	0.17	0.01	0.13	0.00										
2	0.57	0.06	0.34	0.02	0.26	0.01	0.16	0.00								
3	0.85	0.14	0.52	0.04	0.39	0.02	0.25	0.01								
4	1.14	0.23	0.69	0.07	0.53	0.04	0.33	0.01	0.23	0.00						
5	1.42	0.35	0.86	0.11	0.66	0.05	0.42	0.02	0.28	0.01						
6	1.71	0.49	1.04	0.15	0.79	0.08	0.50	0.03	0.34	0.01	0.20	0.00				
7	1.99	0.66	1.21	0.20	0.92	0.10	0.59	0.03	0.40	0.01	0.27	0.01				
8	2.28	0.84	1.39	0.25	1.06	0.13	0.67	0.04	0.46	0.02	0.31	0.01				
9	2.57	1.05	1.56	0.31	1.19	0.16	0.76	0.05	0.52	0.02	0.35	0.01				
10	2.85	1.27	1.73	0.38	1.32	0.20	0.84	0.07	0.57	0.03	0.39	0.01				
11	3.14	1.52	1.91	0.45	1.45	0.23	0.93	0.08	0.63	0.03	0.43	0.01				
12	3.42	1.78	2.085	0.53	1.59	0.28	1.01	0.09	0.69	0.04	0.46	0.01	0.28	0.00		
14	3.99	2.37	2.43	0.71	1.85	0.37	1.18	0.12	0.81	0.05	0.54	0.02	0.33	0.01		
16	4.57	3.04	2.78	0.91	2.12	0.47	1.35	0.16	0.92	0.06	0.62	0.02	0.37	0.01		
18	5.14	3.78	3.12	1.13	2.38	0.58	1.52	0.20	1.04	0.08	0.70	0.03	0.42	0.01		
20	5.71	4.59	3.47	1.37	2.65	0.71	1.69	0.24	1.15	0.09	0.78	0.04	0.47	0.01		
22	6.28	5.48	3.82	1.64	2.91	0.85	1.86	0.29	1.27	0.11	0.86	0.04	0.52	0.01		
24	6.85	6.44	4.17	1.92	3.18	1.00	2.03	0.34	1.38	0.13	0.93	0.05	0.56	0.02		
26	7.42	7.47	4.51	2.23	3.44	1.15	2.20	0.39	1.50	0.15	1.01	0.06	0.61	0.02		
28	7.99	8.57	4.86	2.56	3.71	1.32	2.37	0.45	1.62	0.18	1.09	0.07	0.66	0.02		
30	8.57	9.74	5.21	2.91	3.97	1.50	2.54	0.51	1.73	0.20	1.17	0.08	0.70	0.02		
35	9.99	12.95	6.08	3.87	4.64	2.00	2.96	0.68	2.02	0.27	1.36	0.10	0.82	0.03	0.38	0.00
40	11.42	16.59	6.95	4.95	5.30	2.56	3.39	0.86	2.31	0.34	1.56	0.13	0.94	0.04	0.43	0.01
45	12.85	20.63	7.82	6.16	5.96	3.19	3.81	1.08	2.60	0.42	1.75	0.16	1.06	0.05	0.49	0.01
50	14.28	25.07	8.69	7.49	6.63	3.88	4.24	1.31	2.89	0.52	1.95	0.20	1.18	0.06	0.54	0.01
55	15.71	29.91	9.56	8.93	7.29	4.62	4.66	1.56	3.18	0.62	2.15	0.24	1.30	0.07	0.60	0.01
60	17.14	35.14	10.43	10.49	7.95	5.43	5.09	1.83	3.47	0.72	2.34	0.28	1.41	0.08	0.65	0.01
65	18.57	40.67	11.29	12.17	8.62	6.30	5.51	2.12	3.76	0.84	2.54	0.32	1.53	0.09	0.70	0.01
70	19.99	46.76	12.16	13.96	9.28	7.23	5.93	2.44	4.05	0.96	2.73	0.37	1.65	0.11	0.76	0.02
75			13.03	15.86	9.94	8.21	6.36	2.77	4.34	1.09	2.93	0.42	1.77	0.12	0.81	0.02
80			13.90	17.88	10.60	9.25	6.78	3.12	4.63	1.23	3.12	0.47	1.89	0.14	0.87	0.02
85			14.77	20.00	11.27	10.35	7.21	3.49	4.91	1.38	3.32	0.53	2.00	0.16	0.92	0.02
90			15.64	22.23	11.93	11.51	7.63	3.88	5.20	1.53	3.51	0.59	2.12	0.17	0.98	0.03
95			16.51	24.58	12.59	12.72	8.05	4.29	5.49	1.69	3.71	0.65	2.24	0.19	1.03	0.03
100			17.38	27.03	13.26	13.99	8.48	4.72	5.78	1.86	3.91	0.72	2.36	0.21	1.09	0.03
110			19.12	32.24	14.58	16.69	9.33	5.63	6.36	2.22	4.30	0.86	2.60	0.25	1.20	0.04
120					15.91	19.61	10.18	6.61	6.94	2.61	4.69	1.01	2.83	0.30	1.30	0.05
130					17.24	22.74	11.02	7.67	7.52	3.03	5.08	1.17	3.07	0.34	1.41	0.05
140					18.56	26.09	11.87	8.80	8.10	3.47	5.47	1.34	3.31	0.39	1.52	0.06
150					19.89	29.64	12.72	10.00	8.68	3.94	5.86	1.52	3.54	0.45	1.63	0.07
160							13.57	11.27	9.26	4.45	6.25	1.71	3.78	0.50	1.74	0.08
170							14.42	12.61	9.83	4.97	6.64	1.92	4.01	0.56	1.85	0.09
180							15.27	14.02	10.41	5.53	7.03	2.13	4.25	0.63	1.96	0.10
190							16.11	15.49	10.99	6.11	7.43	2.35	4.49	0.69	2.07	0.11
200							16.96	17.03	11.57	6.72	7.82	2.59	4.72	0.76	2.18	0.12
225							19.08	21.19	13.02	8.36	8.79	3.22	5.31	0.95	2.45	0.14
250									14.47	10.16	9.77	3.91	5.91	1.15	2.72	0.18
275									15.91	12.12	10.75	4.67	6.50	1.37	3.00	0.21
300									17.36	14.24	11.73	5.49	7.09	1.61	3.27	0.25
325									18.81	16.51	12.70	6.36	7.68	1.87	3.54	0.29
350											13.68	7.30	8.27	2.15	3.81	0.33
375											14.66	8.29	8.86	2.44	4.09	0.37
400											15.64	9.35	9.45	2.75	4.36	0.42
425											16.62	10.46	10.04	3.07	4.63	0.47
450											17.59	11.62	10.63	3.42	4.90	0.52
475											18.57	12.85	11.23	3.78	5.18	0.58
500											19.55	14.13	11.82	4.15	5.45	0.63
550													13.00	4.96	6.00	0.76
600													14.18	5.82	6.54	0.89

Note: Shaded areas of the chart indicate velocities over 5 feet per second (FPS). Use with caution.

ROTORS

SPRAY HEADS

ELECTRIC VALVES

CONTROLLERS

INDEX VALVES / RCW

CHARTS

FRICION LOSS CHARTS

PVC CLASS 200 IPS PLASTIC PIPE

Sizes 3/4" thru 6"
Flow GPM 1 thru 600

(1120, 1220) SDR 21 C = 150
PSI loss per 100 feet of pipe (PSI/100 FT)

SIZE	3/4"		1"		1 1/4"		1 1/2"		2"		2 1/2"		3"		4"		6"	
OD	1.050		1.315		1.660		1.900		2.375		2.875		3.500		4.500		6.625	
ID	0.930		1.189		1.502		1.720		2.149		2.601		3.166		4.072		5.993	
WALL THK.	0.060		0.063		0.079		0.090		0.113		0.137		0.167		0.214		0.316	
FLOW G. P. M.	Velocity FPS	psi Loss	Velocity FPS	psi Loss	Velocity FPS	psi Loss	Velocity FPS	psi Loss	Velocity FPS	psi Loss	Velocity FPS	psi Loss	Velocity FPS	psi Loss	Velocity FPS	psi Loss	Velocity FPS	psi Loss
1	0.47	0.06	0.28	0.02	0.18	0.01	0.13	0.00										
2	0.94	0.22	0.57	0.07	0.36	0.02	0.27	0.01	0.17	0.00								
3	1.42	0.46	0.86	0.14	0.54	0.04	0.41	0.02	0.26	0.01	0.18	0.00						
4	1.89	0.79	1.15	0.24	0.72	0.08	0.55	0.04	0.35	0.01	0.24	0.01						
5	2.36	1.20	1.44	0.36	0.90	0.12	0.68	0.06	0.44	0.02	0.30	0.01						
6	2.83	1.68	1.73	0.51	1.08	0.16	0.82	0.08	0.53	0.03	0.36	0.01	0.24	0.00				
7	3.30	2.23	2.02	0.67	1.26	0.22	0.96	0.11	0.61	0.04	0.42	0.01	0.28	0.01				
8	3.77	2.85	2.30	0.86	1.44	0.28	1.10	0.14	0.70	0.05	0.48	0.02	0.32	0.01				
9	4.25	3.55	2.59	1.07	1.62	0.34	1.24	0.18	0.79	0.06	0.54	0.02	0.36	0.01				
10	4.72	4.31	2.88	1.30	1.80	0.42	1.37	0.22	0.88	0.07	0.60	0.03	0.40	0.01				
11	5.19	5.15	3.17	1.56	1.98	0.50	1.51	0.26	0.97	0.09	0.66	0.03	0.44	0.01				
12	5.66	6.05	3.46	1.83	2.17	0.59	1.65	0.30	1.06	0.10	0.72	0.04	0.48	0.02	0.29	0.00		
14	6.60	8.05	4.04	2.43	2.53	0.78	1.93	0.40	1.23	0.14	0.84	0.05	0.56	0.02	0.34	0.01		
16	7.55	10.30	4.61	3.11	2.89	1.00	2.20	0.52	1.41	0.17	0.96	0.07	0.65	0.03	0.39	0.01		
18	8.49	12.81	5.19	3.87	3.25	1.24	2.48	0.64	1.59	0.22	1.08	0.09	0.73	0.03	0.44	0.01		
20	9.43	15.58	5.77	4.71	3.61	1.51	2.75	0.78	1.76	0.26	1.20	0.10	0.81	0.04	0.49	0.01		
22	10.38	18.58	6.34	5.62	3.97	1.80	3.03	0.93	1.94	0.32	1.32	0.12	0.89	0.05	0.54	0.01		
24	11.32	21.83	6.92	6.60	4.34	2.12	3.30	1.09	2.12	0.37	1.44	0.15	0.97	0.06	0.59	0.02		
26	12.27	25.32	7.50	7.65	4.70	2.46	3.58	1.27	2.29	0.43	1.56	0.17	1.05	0.07	0.63	0.02		
28	13.21	29.04	8.08	8.78	5.06	2.82	3.86	1.46	2.47	0.49	1.68	0.19	1.13	0.07	0.68	0.02		
30	14.15	33.00	8.65	9.98	5.42	3.20	4.13	1.66	2.65	0.56	1.80	0.22	1.22	0.09	0.73	0.02	0.34	0.00
35	16.51	43.91	10.10	13.27	6.32	4.26	4.82	2.20	3.09	0.75	2.11	0.29	1.42	0.11	0.86	0.03	0.39	0.01
40	18.87	56.23	11.54	17.00	7.23	5.45	5.51	2.82	3.53	0.95	2.41	0.38	1.62	0.14	0.98	0.04	0.45	0.01
45			12.98	21.14	8.13	6.78	6.20	3.51	3.97	1.19	2.71	0.47	1.83	0.18	1.10	0.05	0.51	0.01
50			14.42	25.70	9.04	8.24	6.89	4.26	4.41	1.44	3.01	0.57	2.03	0.22	1.23	0.06	0.56	0.01
55			15.87	30.66	9.94	9.83	7.58	5.09	4.85	1.72	3.31	0.68	2.23	0.26	1.35	0.08	0.62	0.01
60			17.31	36.02	10.85	11.55	8.27	5.97	5.30	2.02	3.61	0.80	2.44	0.31	1.47	0.09	0.68	0.01
65			18.75	41.77	11.75	13.40	8.96	6.93	5.74	2.35	3.92	0.93	2.64	0.36	1.59	0.10	0.73	0.02
70					12.65	15.37	9.65	7.95	6.18	2.69	4.22	1.06	2.84	0.41	1.72	0.12	0.79	0.02
75					13.56	17.47	10.34	9.03	6.62	3.06	4.52	1.21	3.05	0.46	1.84	0.14	0.85	0.02
80					14.46	19.68	11.03	10.18	7.06	3.44	4.82	1.36	3.25	0.52	1.96	0.15	0.90	0.02
85					15.37	22.02	11.72	11.39	7.50	3.85	5.12	1.52	3.45	0.59	2.09	0.17	0.96	0.03
90					16.27	24.48	12.41	12.66	7.95	4.28	5.42	1.69	3.66	0.65	2.21	0.19	1.02	0.03
95					17.18	27.06	13.10	13.99	8.39	4.74	5.72	1.87	3.86	0.72	2.33	0.21	1.07	0.03
100					18.08	29.76	13.79	15.39	8.83	5.21	6.03	2.06	4.07	0.79	2.46	0.23	1.13	0.04
110					19.89	35.50	15.17	18.36	9.71	6.21	6.63	2.45	4.47	0.94	2.70	0.28	1.24	0.04
120							16.54	21.57	10.60	7.30	7.23	2.88	4.88	1.11	2.95	0.33	1.36	0.05
130							17.92	25.02	11.48	8.47	7.84	3.34	5.29	1.29	3.19	0.38	1.47	0.06
140							19.30	28.70	12.36	9.71	8.44	3.84	5.69	1.47	3.44	0.43	1.59	0.07
150									13.25	11.04	9.04	4.36	6.10	1.68	3.69	0.49	1.70	0.08
160									14.13	12.44	9.64	4.91	6.51	1.89	3.93	0.55	1.81	0.08
170									15.01	13.91	10.25	5.50	6.91	2.11	4.18	0.62	1.93	0.09
180									15.90	15.47	10.85	6.11	7.32	2.35	4.42	0.69	2.04	0.11
190									16.78	17.10	11.45	6.75	7.73	2.60	4.67	0.76	2.15	0.12
200									17.66	18.80	12.06	7.43	8.14	2.85	4.92	0.84	2.27	0.13
225									19.87	23.38	13.56	9.24	9.15	3.55	5.53	1.04	2.55	0.16
250											15.07	11.23	10.17	4.31	6.15	1.27	2.83	0.19
275											16.58	13.39	11.19	5.15	6.76	1.51	3.12	0.23
300											18.09	15.74	12.21	6.05	7.38	1.78	3.40	0.27
325											19.60	18.25	13.22	7.01	7.99	2.06	3.69	0.31
350													14.24	8.05	8.61	2.36	3.97	0.36
375													15.26	9.14	9.22	2.69	4.25	0.41
400													16.28	10.30	9.84	3.03	4.54	0.46
425													17.29	11.53	10.45	3.396	4.82	0.52
450													18.31	12.81	11.07	3.77	5.11	0.57
475													19.33	14.16	11.68	4.16	5.39	0.63
500															12.30	4.58	5.67	0.70
550															13.53	5.46	6.24	0.83
600															14.76	6.42	6.81	0.98

Note: Shaded areas of the chart indicate velocities over 5 feet per second (FPS). Use with caution.

PVC CLASS 315 IPS PLASTIC PIPE

 Sizes 1/2" thru 6"
 Flow GPM 1 thru 600

 (1120, 1220) SDR 13.5 C = 150
 PSI loss per 100 feet of pipe (PSI/100 FT)

SIZE	1/2"		3/4"		1"		1 1/4"		1 1/2"		2"		2 1/2"		3"		4"		6"	
OD	0.840		1.050		1.315		1.660		1.900		2.375		2.875		3.500		4.500		6.625	
ID	0.716		0.894		1.121		1.414		1.618		2.023		2.449		2.982		3.834		5.643	
WALL THK.	0.062		0.078		0.097		0.123		0.141		0.176		0.213		0.259		0.333		0.491	
FLOW G. P. M.	Velocity FPS	psi Loss	Velocity FPS	psi Loss	Velocity FPS	psi Loss	Velocity FPS	psi Loss	Velocity FPS	psi Loss	Velocity FPS	psi Loss	Velocity FPS	psi Loss	Velocity FPS	psi Loss	Velocity FPS	psi Loss	Velocity FPS	psi Loss
1	0.79	0.22	0.51	0.07	0.32	0.02	0.20	0.01	0.15	0.00										
2	1.59	0.78	1.02	0.27	0.64	0.09	0.40	0.03	0.31	0.01	0.19	0.00								
3	2.38	1.65	1.53	0.56	0.97	0.19	0.61	0.06	0.46	0.03	0.29	0.01	0.20	0.00						
4	3.18	2.82	2.04	0.96	1.29	0.32	0.81	0.10	0.62	0.05	0.39	0.02	0.27	0.01						
5	3.97	4.26	2.55	1.45	1.62	0.48	1.02	0.16	0.77	0.08	0.49	0.03	0.34	0.01	0.22	0.00				
6	4.77	5.97	3.06	2.03	1.94	0.67	1.22	0.22	0.93	0.11	0.59	0.04	0.40	0.02	0.27	0.01				
7	5.57	7.95	3.57	2.70	2.27	0.90	1.42	0.29	1.09	0.15	0.69	0.05	0.47	0.02	0.32	0.01				
8	6.36	10.18	4.08	3.45	2.59	1.15	1.63	0.37	1.24	0.19	0.79	0.06	0.54	0.03	0.36	0.01				
9	7.16	12.66	4.59	4.30	2.92	1.43	1.83	0.46	1.40	0.24	0.89	0.08	0.61	0.03	0.41	0.01				
10	7.95	15.38	5.10	5.22	3.24	1.74	2.04	0.56	1.55	0.29	0.99	0.10	0.68	0.04	0.45	0.01	0.27	0.00		
11	8.75	18.35	5.61	6.23	3.57	2.07	2.24	0.67	1.71	0.35	1.09	0.12	0.74	0.05	0.50	0.02	0.30	0.01		
12	9.55	21.56	6.12	7.32	3.89	2.43	2.44	0.79	1.87	0.41	1.19	0.14	0.81	0.05	0.55	0.02	0.33	0.01		
14	11.14	28.69	7.14	9.74	4.54	3.24	2.85	1.05	2.18	0.54	1.39	0.18	0.95	0.07	0.64	0.03	0.38	0.01		
16	12.73	36.74	8.16	12.47	5.19	4.15	3.26	1.34	2.49	0.70	1.59	0.23	1.08	0.09	0.73	0.04	0.44	0.01		
18	14.32	45.69	9.18	15.51	5.84	5.16	3.67	1.67	2.80	0.87	1.79	0.29	1.22	0.12	0.82	0.04	0.49	0.01		
20	15.91	55.54	10.20	18.86	6.49	6.27	4.08	2.03	3.11	1.05	1.99	0.35	1.36	0.14	0.91	0.05	0.55	0.02		
22	17.50	66.26	11.23	22.50	7.14	7.48	4.48	2.42	3.42	1.25	2.19	0.42	1.49	0.17	1.00	0.06	0.61	0.02		
24	19.10	77.84	12.25	26.43	7.79	8.79	4.89	2.84	3.74	1.47	2.39	0.50	1.63	0.20	1.10	0.08	0.66	0.02		
26			13.27	30.65	8.44	10.19	5.30	3.29	4.05	1.71	2.59	0.58	1.76	0.23	1.19	0.09	0.72	0.03		
28			14.29	35.16	9.09	11.69	5.71	3.78	4.36	1.96	2.79	0.66	1.90	0.26	1.28	0.10	0.77	0.03	0.35	0.00
30			15.31	39.95	9.74	13.29	6.12	4.29	4.67	2.23	2.99	0.75	2.04	0.30	1.37	0.11	0.83	0.03	0.38	0.01
35			17.86	53.15	11.36	17.68	7.14	5.71	5.45	2.96	3.48	1.00	2.38	0.39	1.60	0.15	0.97	0.04	0.44	0.01
40					12.98	22.64	8.16	7.31	6.23	3.80	3.98	1.28	2.72	0.51	1.83	0.19	1.11	0.06	0.51	0.01
45					14.61	28.15	9.18	9.10	7.01	4.72	4.48	1.59	3.06	0.63	2.06	0.24	1.24	0.07	0.57	0.01
50					16.23	34.22	10.20	11.06	7.79	5.74	4.98	1.94	3.40	0.76	2.29	0.29	1.38	0.09	0.64	0.01
55					17.85	40.83	11.22	13.19	8.57	6.85	5.48	2.31	3.74	0.91	2.52	0.35	1.52	0.10	0.70	0.02
60					19.48	47.97	12.24	15.50	9.35	8.04	5.98	2.71	4.08	1.07	2.75	0.41	1.66	0.12	0.76	0.02
65							13.26	17.97	10.13	9.33	6.48	3.15	4.42	1.24	2.98	0.48	1.80	0.14	0.83	0.02
70							14.28	20.62	10.90	10.70	6.97	3.61	4.76	1.42	3.21	0.55	1.94	0.16	0.89	0.02
75							15.30	23.43	11.68	12.16	7.47	4.10	5.10	1.62	3.44	0.62	2.08	0.18	0.96	0.03
80							16.32	26.40	12.46	13.71	7.97	4.62	5.44	1.82	3.67	0.70	2.22	0.21	1.02	0.03
85							17.34	29.54	13.24	15.33	8.47	5.17	5.78	2.04	3.89	0.78	2.35	0.23	1.08	0.04
90							18.36	32.84	14.02	17.05	8.97	5.75	6.12	2.27	4.12	0.87	2.49	0.26	1.15	0.04
95							19.38	36.30	14.80	18.84	9.47	6.35	6.46	2.51	4.35	0.96	2.63	0.28	1.21	0.04
100									15.58	20.72	9.96	6.99	6.80	2.76	4.58	1.06	2.77	0.31	1.28	0.05
110									17.14	24.72	10.96	8.34	7.48	3.29	5.04	1.26	3.05	0.37	1.40	0.06
120									18.70	29.04	11.96	9.79	8.16	3.87	5.50	1.48	3.33	0.44	1.53	0.07
130											12.96	11.36	8.84	4.48	5.96	1.72	3.60	0.51	1.66	0.08
140											13.95	13.03	9.52	5.14	6.42	1.97	3.88	0.58	1.79	0.09
150											14.95	14.81	10.20	5.84	6.88	2.24	4.16	0.66	1.92	0.10
160											15.95	16.69	10.88	6.59	7.34	2.53	4.44	0.74	2.04	0.11
170											16.94	18.67	11.56	7.37	7.79	2.83	4.71	0.83	2.17	0.13
180											17.94	20.75	12.24	8.19	8.25	3.14	4.99	0.93	2.30	0.14
190											18.94	22.94	12.92	9.05	8.71	3.47	5.27	1.02	2.43	0.16
200											19.93	25.23	13.60	9.95	9.17	3.82	5.55	1.12	2.56	0.17
225													15.30	12.38	10.32	4.75	6.24	1.40	2.88	0.21
250													17.00	15.05	11.47	5.77	6.93	1.70	3.20	0.26
275													18.70	17.95	12.61	6.89	7.63	2.03	3.52	0.31
300															13.76	8.09	8.32	2.38	3.84	0.36
325															14.91	9.39	9.02	2.76	4.16	0.42
350															16.05	10.77	9.71	3.17	4.48	0.48
375															17.20	12.23	10.40	3.60	4.80	0.55
400															18.35	13.79	11.10	4.06	5.12	0.62
425															19.49	15.42	11.79	4.54	5.44	0.69
450																	12.49	5.05	5.76	0.77
475																	13.18	5.58	6.08	0.85
500																	13.87	6.14	6.40	0.94
550																	15.26	7.32	7.04	1.12
600																	16.65	8.60	7.68	1.31

Note: Shaded areas of the chart indicate velocities over 5 feet per second (FPS). Use with caution.

FRICION LOSS CHARTS

POLYETHYLENE (PE) SDR-PRESSURE RATED TUBE

Sizes 1/2" thru 6"
Flow GPM 1 thru 600

(2306, 3206, 3306) SDR 7, 9, 11.5, 15 C = 140
PSI loss per 100 feet of tube (PSI/100 FT)

SIZE	1/2"		3/4"		1"		1 1/4"		1 1/2"		2"		2 1/2"		3"		4"		6"	
ID	0.622		0.824		1.049		1.380		1.610		2.067		2.469		3.068		4.026		6.065	
FLOW G. P. M.	Velocity FPS	psi Loss	Velocity FPS	psi Loss	Velocity FPS	psi Loss	Velocity FPS	psi Loss	Velocity FPS	psi Loss	Velocity FPS	psi Loss	Velocity FPS	psi Loss	Velocity FPS	psi Loss	Velocity FPS	psi Loss	Velocity FPS	psi Loss
1	1.05	0.49	0.60	0.12	0.37	0.04	0.21	0.01	0.15	0.00	0.09	0.00								
2	2.10	1.76	1.20	0.45	0.74	0.14	0.42	0.04	0.31	0.02	0.19	0.01								
3	3.16	3.73	1.80	0.95	1.11	0.29	0.64	0.08	0.47	0.04	0.28	0.01	0.20	0.00						
4	4.21	6.35	2.40	1.62	1.48	0.50	0.85	0.13	0.62	0.06	0.38	0.02	0.26	0.01						
5	5.27	9.60	3.00	2.44	1.85	0.76	1.07	0.20	0.78	0.09	0.47	0.03	0.33	0.01	0.21	0.00				
6	6.32	13.46	3.60	3.43	2.22	1.06	1.28	0.28	0.94	0.13	0.57	0.04	0.40	0.02	0.26	0.01				
7	7.38	17.91	4.20	4.56	2.59	1.41	1.49	0.37	1.10	0.18	0.66	0.05	0.46	0.02	0.30	0.01				
8	8.43	22.93	4.80	5.84	2.96	1.80	1.71	0.474	1.25	0.22	0.76	0.07	0.53	0.03	0.34	0.03				
9	9.49	28.52	5.40	7.26	3.33	2.24	1.92	0.59	1.41	0.28	0.85	0.08	0.60	0.03	0.39	0.01				
10	10.54	34.67	6.00	8.82	3.70	2.73	2.14	0.72	1.57	0.34	0.95	0.10	0.66	0.04	0.43	0.01				
11	11.60	41.36	6.00	10.53	4.07	3.25	2.35	0.86	1.73	0.40	1.05	0.12	0.73	0.05	0.47	0.02	0.27	0.00		
12	12.65	48.60	7.21	12.37	4.44	3.82	2.57	1.01	1.88	0.48	1.14	0.14	0.80	0.06	0.52	0.02	0.30	0.01		
14	14.76	64.65	8.41	16.46	5.19	5.08	2.99	1.34	2.20	0.63	1.33	0.19	0.93	0.08	0.60	0.03	0.35	0.01		
16	16.87	82.79	9.61	21.07	5.93	6.51	3.42	1.71	2.51	0.81	1.52	0.24	1.07	0.10	0.69	0.04	0.40	0.01		
18	18.89	102.97	10.81	26.21	6.67	8.10	3.85	2.13	2.83	1.01	1.71	0.30	1.20	0.13	0.78	0.04	0.45	0.01		
20			12.01	31.86	7.41	9.84	4.28	2.59	3.14	1.22	1.90	0.36	1.33	0.15	0.86	0.05	0.50	0.01		
22			13.21	38.01	8.15	11.74	4.71	3.09	3.46	1.46	2.10	0.43	1.47	0.18	0.95	0.06	0.55	0.02		
24			14.42	44.65	8.89	13.79	5.14	3.63	3.77	1.72	2.29	0.51	1.60	0.21	1.04	0.07	0.60	0.02		
26			15.62	41.79	9.64	16.00	5.57	4.21	4.09	1.99	2.48	0.59	1.74	0.25	1.12	0.09	0.65	0.02		
28			16.82	59.41	10.38	18.35	5.99	4.83	4.40	2.28	2.67	0.68	1.87	0.29	1.21	0.10	0.70	0.03		
30			18.02	67.50	11.12	20.85	6.42	5.49	4.72	2.59	2.86	0.77	2.00	0.32	1.30	0.11	0.75	0.03	0.33	0.00
35					12.97	27.74	7.49	7.31	5.50	3.45	3.34	1.02	2.34	0.43	1.51	0.15	0.88	0.04	0.38	0.01
40					14.83	35.53	8.56	9.36	6.29	4.42	3.81	1.31	2.67	0.55	1.73	0.19	1.00	0.05	0.44	0.01
45					16.68	44.19	9.64	11.64	7.08	5.50	4.29	1.63	3.01	0.69	1.95	0.24	1.13	0.06	0.49	0.01
50					18.53	53.71	10.71	14.14	7.87	6.68	4.77	1.98	3.34	0.83	2.16	0.29	1.25	0.08	0.55	0.01
55							11.78	16.87	8.65	7.97	5.25	2.36	3.68	1.00	2.38	0.35	1.38	0.09	0.61	0.01
60							12.85	19.82	9.44	9.36	5.72	2.78	4.01	1.17	2.60	0.41	1.51	0.11	0.66	0.01
65							13.92	22.99	10.23	10.86	6.20	3.22	4.35	1.36	2.81	0.47	1.63	0.13	0.72	0.02
70							14.99	26.37	11.01	12.46	6.68	3.69	4.68	1.56	3.03	0.54	1.76	0.14	0.77	0.02
75							16.06	29.97	11.80	14.16	7.16	4.20	5.01	1.77	3.25	0.61	1.88	0.16	0.83	0.02
80							17.13	33.77	12.59	15.95	7.63	4.73	5.35	1.99	3.46	0.69	2.01	0.18	0.88	0.03
85							18.21	37.79	13.37	17.85	8.11	5.29	5.68	2.23	3.68	0.77	2.13	0.21	0.94	0.03
90							19.28	42.01	14.16	19.84	8.59	5.88	6.02	2.48	3.90	0.86	2.26	0.23	0.99	0.03
95									14.95	21.93	9.07	6.50	6.35	2.74	4.11	0.95	2.39	0.25	1.05	0.03
100									15.74	24.12	9.54	7.15	6.69	3.01	4.33	1.05	2.51	0.28	1.10	0.04
110									17.31	28.77	10.50	8.53	7.36	3.59	4.76	1.25	2.76	0.33	1.22	0.05
120									18.88	33.80	11.45	10.02	8.03	4.22	5.20	1.47	3.02	0.39	1.33	0.05
130											12.41	11.62	8.70	4.90	5.63	1.70	3.27	0.45	1.44	0.06
140											13.36	13.33	9.37	5.62	6.06	1.95	3.52	0.52	1.55	0.07
150											14.32	15.15	10.03	6.38	6.50	2.22	3.77	0.59	1.66	0.08
160											15.27	17.08	10.70	7.19	6.93	2.50	4.02	0.67	1.77	0.09
170											16.23	19.11	11.37	8.05	7.36	2.80	4.27	0.75	1.88	0.10
180											17.18	21.24	12.04	8.95	7.08	3.11	4.53	0.83	1.99	0.11
190											18.14	23.48	12.71	9.89	8.23	3.44	4.78	0.92	2.10	0.12
200											19.09	25.81	13.38	10.87	8.66	3.78	5.03	1.01	2.21	0.14
225													15.05	13.52	9.75	4.70	5.66	1.25	2.49	0.17
250													16.73	16.44	10.83	5.71	6.29	1.52	2.77	0.21
275													18.40	19.61	11.92	6.82	6.92	1.82	3.05	0.25
300															13.00	8.01	7.55	2.13	3.32	0.29
325															14.08	9.29	8.18	2.48	3.60	0.34
350															15.17	10.65	8.81	2.84	3.88	0.39
375															16.25	12.10	9.43	3.23	4.15	0.44
400															17.33	13.64	10.06	3.64	4.43	0.50
425															18.42	15.26	10.69	4.07	4.71	0.55
450															19.50	16.97	11.32	4.52	4.99	0.62
475																	11.95	5.00	5.26	0.68
500																	12.58	5.50	5.54	0.75
550																	13.84	6.56	6.10	0.89
600																	15.10	7.70	6.65	1.05

Note: Shaded areas of the chart indicate velocities over 5 feet per second (FPS). Use with caution.

TYPE K COPPER WATER TUBE

 Sizes 1/2" thru 3"
 Flow GPM 1 thru 600

 C = 140
 PSI loss per 100 feet of tube (PSI/100 FT)

SIZE	1/2"		5/8"		3/4"		1"		1 1/4"		1 1/2"		2"		2 1/2"		3"	
OD	0.625		0.750		0.875		1.125		1.375		1.625		2.125		2.625		3.125	
ID	0.527		0.652		0.745		0.995		1.245		1.481		1.959		2.435		2.907	
WALL THK.	0.049		0.049		0.065		0.065		0.065		0.072		0.083		0.095		0.109	
FLOW G. P. M.	Velocity FPS	psi Loss	Velocity FPS	psi Loss	Velocity FPS	psi Loss	Velocity FPS	psi Loss	Velocity FPS	psi Loss	Velocity FPS	psi Loss	Velocity FPS	psi Loss	Velocity FPS	psi Loss	Velocity FPS	psi Loss
1	1.45	1.09	0.95	0.39	0.73	0.20	0.41	0.05	0.26	0.02	0.18	0.01	0.10	0.00				
2	2.93	3.94	1.91	1.40	1.47	0.73	0.82	0.18	0.52	0.06	0.37	0.03	0.21	0.01				
3	4.40	8.35	2.87	2.974	2.20	1.55	1.23	0.38	0.78	0.13	0.55	0.05	0.31	0.01	0.20	0.00		
4	5.87	14.23	3.83	5.05	2.94	2.64	1.64	0.65	1.05	0.22	0.74	0.09	0.42	0.02	0.27	0.01	0.19	0.00
5	7.34	21.51	4.79	7.64	3.67	3.99	2.06	0.98	1.31	0.33	0.93	0.14	0.53	0.04	0.34	0.01	0.24	0.01
6	8.81	30.15	5.75	10.70	4.41	5.60	2.47	1.37	1.57	0.46	1.11	0.20	0.63	0.05	0.41	0.02	0.28	0.01
7	10.28	40.11	6.71	14.24	5.14	7.44	2.88	1.82	1.84	0.61	1.30	0.26	0.74	0.07	0.48	0.02	0.33	0.01
8	11.75	51.37	7.67	18.24	5.88	9.53	3.29	2.33	2.10	0.78	1.48	0.34	0.85	0.09	0.55	0.03	0.38	0.01
9	13.22	63.89	8.63	22.68	6.61	11.86	3.70	2.90	2.36	0.97	1.67	0.42	0.95	0.11	0.61	0.04	0.43	0.02
10	14.69	77.66	9.59	27.57	7.35	14.41	4.12	3.53	2.63	1.18	1.86	0.51	1.06	0.13	0.68	0.05	0.48	0.02
11	16.15	92.65	10.55	32.89	8.08	17.19	4.53	4.21	2.89	1.41	2.04	0.61	1.16	0.16	0.75	0.05	0.53	0.02
12	17.62	108.85	11.51	38.64	8.82	20.20	4.94	4.94	3.15	1.66	2.23	0.71	1.27	0.18	0.82	0.06	0.57	0.03
14			13.43	51.41	10.29	26.87	5.76	6.57	3.68	2.21	2.60	0.95	1.48	0.24	0.95	0.08	0.67	0.04
16			15.35	65.83	11.76	34.41	6.59	8.42	4.21	2.83	2.97	1.22	1.70	0.31	1.10	0.11	0.77	0.05
18			17.27	81.88	13.23	42.80	7.41	10.47	4.73	3.52	3.34	1.51	1.91	0.39	1.23	0.13	0.86	0.06
20			19.19	99.53	14.70	52.02	8.24	12.73	5.26	4.28	3.72	1.84	2.12	0.47	1.37	0.16	0.96	0.07
22					16.17	62.06	9.06	15.18	5.79	5.10	4.09	2.19	2.33	0.56	1.51	0.20	1.06	0.08
24					17.64	72.92	9.89	17.84	6.31	5.99	4.46	2.58	2.55	0.66	1.65	0.23	1.15	0.10
26					19.11	84.57	10.71	20.69	6.84	6.95	4.83	2.99	2.76	0.77	1.78	0.27	1.25	0.11
28							11.53	23.73	7.37	7.98	5.20	3.43	2.97	0.88	1.92	0.30	1.35	0.13
30							12.36	26.97	7.89	9.06	5.58	3.89	3.18	1.00	2.06	0.35	1.44	0.15
35							14.42	35.88	9.21	12.06	6.51	5.18	3.72	1.33	2.40	0.46	1.68	0.19
40							16.48	45.95	10.52	15.44	7.44	6.63	4.25	1.70	2.75	0.59	1.93	0.25
45							18.54	57.15	11.84	19.20	8.37	8.25	4.78	2.12	3.00	0.73	2.17	0.31
50									13.16	23.34	9.30	10.03	5.31	2.57	3.44	0.89	2.41	0.38
55									14.47	27.85	10.23	11.97	5.84	3.07	3.78	1.06	2.65	0.45
60									15.79	32.71	11.16	14.06	6.37	3.60	4.12	1.25	2.89	0.53
65									17.10	37.94	12.09	16.31	6.91	4.18	4.47	1.45	3.13	0.61
70									18.42	43.52	13.02	18.70	7.44	4.80	4.81	1.66	3.37	0.70
75									19.74	49.45	13.95	21.25	7.97	5.45	5.16	1.89	3.62	0.80
80											14.88	23.95	8.50	6.14	5.50	2.13	3.86	0.90
85											15.81	26.80	9.03	6.87	5.84	2.38	4.10	1.01
90											16.74	29.79	9.56	7.64	6.19	2.65	4.34	1.12
95											17.67	32.93	10.09	8.44	6.53	2.93	4.58	1.24
100											18.60	36.21	10.63	9.28	6.88	3.22	4.82	1.36
110													11.69	11.08	7.56	3.84	5.31	1.62
120													12.75	13.01	8.25	4.52	5.79	1.91
130													13.82	15.09	8.94	5.24	6.27	2.21
140													14.88	17.31	9.63	6.01	6.75	2.54
150													15.94	19.67	10.32	6.83	7.24	2.88
160													17.01	22.17	11.00	7.69	7.72	3.25
170													18.07	24.81	11.69	8.61	8.20	3.64
180													19.13	27.58	12.38	9.57	8.69	4.04
190															13.07	10.58	9.17	4.47
200															13.76	11.63	9.65	4.91
225															15.48	14.47	10.86	6.11
250															17.20	17.58	12.07	7.43
275															18.92	20.98	13.27	8.86
300																	14.48	10.41
325																	15.69	12.07
350																	16.89	13.85
375																	18.10	15.73
400																	19.31	17.73
425																		
450																		
475																		
500																		
550																		
600																		

Note: Shaded areas of the chart indicate velocities over 5 feet per second (FPS). Use with caution.

FRICION LOSS CHARTS

SCHEDULE 40 STANDARD STEEL PIPE

Sizes 1/2" thru 6"
Flow GPM 1 thru 600

C = 100
PSI loss per 100 feet of pipe (PSI/100 FT)

SIZE	1/2"		3/4"		1"		1 1/4"		1 1/2"		2"		2 1/2"		3"		4"		6"	
OD	0.840		1.050		1.315		1.660		1.900		2.375		2.875		3.500		4.500		6.625	
ID	0.622		0.824		1.049		1.380		1.610		2.067		2.469		3.068		4.026		6.065	
WALL THK.	0.109		0.113		0.133		0.140		0.145		0.154		0.203		0.216		0.237		0.280	
FLOW G. P. M.	Velocity FPS	psi Loss	Velocity FPS	psi Loss	Velocity FPS	psi Loss	Velocity FPS	psi Loss	Velocity FPS	psi Loss	Velocity FPS	psi Loss	Velocity FPS	psi Loss	Velocity FPS	psi Loss	Velocity FPS	psi Loss	Velocity FPS	psi Loss
1	1.05	0.91	0.60	0.23	0.37	0.07	0.21	0.02	0.15	0.01	0.09	0.00								
2	2.10	3.28	1.20	0.84	0.74	0.26	0.42	0.07	0.31	0.03	0.19	0.01	0.13	0.00						
3	3.16	6.95	1.80	1.77	1.11	0.55	0.64	0.14	0.47	0.07	0.28	0.02	0.20	0.01	0.13	0.00				
4	4.21	11.85	2.40	3.02	1.48	0.93	0.85	0.25	0.62	0.12	0.38	0.03	0.26	0.01	0.17	0.01				
5	5.27	17.91	3.00	4.56	1.85	1.41	1.07	0.37	0.78	0.18	0.47	0.05	0.33	0.02	0.21	0.01				
6	6.32	25.10	3.60	6.39	2.22	1.97	1.28	0.52	0.94	0.25	0.57	0.07	0.40	0.03	0.26	0.01				
7	7.38	33.40	4.20	8.50	2.59	2.63	1.49	0.69	1.10	0.33	0.66	0.10	0.46	0.04	0.30	0.01				
8	8.43	42.77	4.80	10.89	2.96	3.36	1.71	0.89	1.25	0.42	0.76	0.12	0.53	0.05	0.34	0.02	0.20	0.00		
9	9.49	53.19	5.40	13.54	3.33	4.18	1.92	1.10	1.41	0.52	0.85	0.15	0.60	0.06	0.39	0.02	0.22	0.01		
10	10.54	64.65	6.00	16.46	3.70	5.08	2.14	1.34	1.57	0.63	0.95	0.19	0.66	0.08	0.43	0.03	0.25	0.01		
11	11.60	77.13	6.60	19.63	4.07	6.07	2.35	1.60	1.73	0.75	1.05	0.22	0.73	0.09	0.47	0.03	0.27	0.01		
12	12.65	90.62	7.21	23.07	4.44	7.13	2.57	1.88	1.88	0.89	1.14	0.26	0.80	0.11	0.52	0.04	0.30	0.01		
14	14.76	20.56	8.41	30.69	5.19	9.48	2.99	2.50	2.20	1.18	1.33	0.35	0.93	0.15	0.60	0.05	0.35	0.01		
16	16.87	54.39	9.61	39.30	5.93	12.14	3.42	3.20	2.51	1.51	1.52	0.45	1.07	0.19	0.69	0.07	0.40	0.02		
18	18.89	92.02	10.81	48.88	6.67	15.10	3.85	3.98	2.83	1.88	1.71	0.56	1.20	0.23	0.78	0.08	0.45	0.02		
20			12.01	59.41	7.41	18.35	4.28	4.83	3.14	2.28	1.90	0.68	1.33	0.29	0.86	0.10	0.50	0.03		
22			13.21	70.88	8.15	21.90	4.71	5.77	3.46	2.72	2.10	0.81	1.47	0.34	0.95	0.12	0.55	0.03	0.24	0.00
24			14.42	83.27	8.89	25.72	5.14	6.77	3.77	3.20	2.29	0.95	1.60	0.40	1.04	0.14	0.60	0.04	0.26	0.01
26			15.62	96.57	9.64	29.83	5.57	7.86	4.09	3.71	2.48	1.10	1.74	0.46	1.12	0.16	0.65	0.04	0.28	0.01
28			16.82	110.8	10.38	34.22	5.99	9.01	4.40	4.26	2.67	1.26	1.87	0.53	1.21	0.18	0.70	0.05	0.31	0.01
30			18.02	125.9	11.12	38.89	6.42	10.24	4.72	4.84	2.86	1.43	2.00	0.60	1.30	0.21	0.75	0.06	0.33	0.01
35					12.97	51.74	7.49	13.62	5.50	6.44	3.34	1.91	2.34	0.80	1.51	0.28	0.88	0.07	0.38	0.01
40					14.83	66.25	8.56	17.45	6.29	8.24	3.81	2.44	2.67	1.03	1.73	0.36	1.00	0.10	0.44	0.01
45					16.68	82.40	9.64	21.70	7.08	10.25	4.29	3.04	3.01	1.28	1.95	0.44	1.13	0.12	0.49	0.02
50					18.53	100.2	10.71	26.37	7.87	12.46	4.77	3.69	3.34	1.56	2.16	0.54	1.25	0.14	0.55	0.02
55							11.78	31.47	8.65	14.86	5.25	4.41	3.68	1.86	2.38	0.65	1.38	0.17	0.61	0.02
60							12.85	36.97	9.44	17.46	5.72	5.18	4.01	2.18	2.60	0.76	1.51	0.20	0.66	0.03
65							13.92	42.88	10.23	20.25	6.20	6.00	4.35	2.53	2.81	0.88	1.63	0.23	0.72	0.03
70							14.99	49.18	11.01	23.23	6.68	6.89	4.68	2.90	3.03	1.01	1.76	0.27	0.77	0.04
75							16.06	55.89	11.80	26.40	7.16	7.83	5.01	3.30	3.25	1.15	1.88	0.31	0.83	0.04
80							17.13	62.98	12.59	29.75	7.63	8.82	5.35	3.72	3.46	1.29	2.01	0.34	0.88	0.05
85							18.21	70.47	13.37	33.29	8.11	9.87	5.68	4.16	3.68	1.44	2.13	0.39	0.94	0.05
90							19.28	78.33	14.16	37.00	8.59	10.97	6.02	4.62	3.90	1.61	2.26	0.43	0.99	0.06
95									14.95	40.90	9.07	12.13	6.35	5.11	4.11	1.78	2.39	0.47	1.05	0.06
100									15.74	44.97	9.54	13.33	6.69	5.62	4.33	1.95	2.51	0.52	1.10	0.07
110									17.31	53.66	10.50	15.91	7.36	6.7	4.76	2.33	2.76	0.62	1.22	0.08
120									18.88	63.04	11.45	18.69	8.03	7.87	5.20	2.74	3.02	0.73	1.33	0.10
130											12.41	21.68	8.70	9.13	5.63	3.17	3.27	0.85	1.44	0.12
140											13.36	24.87	9.37	10.47	6.06	3.64	3.52	0.97	1.55	0.13
150											14.32	28.26	10.03	11.90	6.50	4.14	3.77	1.10	1.66	0.15
160											15.27	31.84	10.70	13.41	6.93	4.66	4.02	1.24	1.77	0.17
170											16.23	35.63	11.37	15.01	7.36	5.22	4.27	1.39	1.88	0.19
180											17.18	39.61	12.04	16.68	7.80	5.80	4.53	1.55	1.99	0.21
190											18.14	43.78	12.71	18.44	8.23	6.41	4.78	1.71	2.10	0.23
200											19.09	48.14	13.38	20.28	8.66	7.05	5.03	1.88	2.21	0.26
225													15.08	25.22	9.75	8.76	5.66	2.34	2.49	0.32
250													16.73	30.65	10.83	10.65	6.29	2.84	2.77	0.39
275													18.40	36.57	11.92	12.71	6.92	3.39	3.05	0.46
300															13.00	14.93	7.55	3.98	3.32	0.54
325															14.08	17.32	8.18	4.62	3.60	0.63
350															15.17	19.87	8.81	5.30	3.88	0.72
375															16.25	22.57	9.43	6.02	4.15	0.82
400															17.33	25.44	10.06	6.78	4.43	0.92
425															18.42	28.46	10.69	7.59	4.71	1.03
450															19.50	31.64	11.32	8.43	4.99	1.15
475																	11.95	9.32	5.26	1.27
500																	12.58	10.25	5.54	1.40
550																	13.84	12.23	6.10	1.67
600																	15.10	14.37	6.65	1.96

Note: Shaded areas of the chart indicate velocities over 5 feet per second (FPS). Use with caution.

All K-Rain gear drive rotors carry a five year *“Limited Warranty”* from the date of purchase. All other K-Rain products carry a two year *“Limited Warranty”* from the date of purchase unless otherwise stated. During this period K-Rain will repair or replace (at K-Rain’s option) the product or any part if the product is found to be defective as to workmanship or material.

This warranty does not extend to damage to a K-Rain product resulting from misuse, neglect or abuse, normal wear and tear, or accident, to exterior appearance or color or due to improper installation. Various products may carry a longer warranty time period; check individual product specification sheets for warranty period.

This warranty extends only to an original user of a K-Rain product.

IN NO EVENT SHALL K-RAIN BE LIABLE FOR INCIDENTAL OR CONSEQUENTIAL DAMAGES. ALL IMPLIED WARRANTIES ARE LIMITED IN DURATION TO TWO YEARS FOLLOWING DATE OF PURCHASE UNLESS INDICATED OTHERWISE.

Some U.S. states do not permit the exclusion or limitation of incidental or consequential damages or of implied warranties. Therefore, the above exclusions or limitations may not apply to you. If a defect arises in a K-Rain product within the warranty period, you should promptly contact your K-Rain installer, distributor or K-RAIN MANUFACTURING CORPORATION.

This warranty gives you specific legal rights, and you may also have other rights which vary from state to state. If you have any questions concerning the warranty or its application, please contact K-Rain:

K-Rain Manufacturing Corp.

1640 Australian Avenue
Riviera Beach, FL 33404 USA
+1 561 844-1002
FAX: +1 561 842-9493

1.800.735.7246 | www.krain.com

Authorized Partner



RADIONICA ZA ZELENO I PLAVO

NATURALIST d.o.o. • Petra Konjovića 12-ž, 11090 Beograd, Srbija

Tel: +381 11 7514898 • Fax: +381 11 7514899

e-mail: naturalist.office@gmail.com • e-mail: office@naturalist.rs

www.naturalist.rs



K-Rain Manufacturing Corp.

1640 Australian Avenux

Riviera Beach, FL 33404 USA

+1 561 844-1002

FAX: +1 561 842-9493

1.800.735.7246 | www.krain.com

© K-Rain Manufacturing Corporation
AN ISO 9001:2008 CERTIFIED COMPANY